

Magellan® eXplorist™ XL



Reference Manual



*****WARNINGS*****

IN THE INTEREST OF SAFETY, DO NOT USE THIS NAVIGATION DEVICE WHILE DRIVING A VEHICLE.

Please do not try and change any settings on the Magellan eXplorist while driving. Come to a complete stop or have a passenger make any changes. Taking your eyes off the road is dangerous and can result in an accident in which you or others could be injured.

USE GOOD JUDGEMENT

This product is an excellent navigation aid, but does not replace the need for careful orienteering and good judgement. Never rely solely on one device for navigating.

USE CARE

The Global Positioning System (GPS) is operated by the U.S. Government, which is solely responsible for the accuracy and maintenance of the GPS network. The accuracy of position fixes can be affected by the periodic adjustments to GPS satellites made by the U.S. government and is subject to change in accordance with the Department of Defense civil GPS user policy and the Federal Radionavigation Plan. Accuracy can also be affected by poor satellite geometry and obstructions, like buildings and large trees.

USE PROPER ACCESSORIES

Use only Magellan cables and antennas; the use of non-Magellan cables and antennas may severely degrade performance or damage the receiver, and will void the warranty.

LICENSE AGREEMENT

Thales grants you, the purchaser, the right to use the software supplied in and with Thales Navigation GPS products (the "SOFTWARE") in the normal operation of the equipment in accordance with the terms of the End User License Agreement that is with the product.

The SOFTWARE is the property of Thales and/or its suppliers and is protected by United States copyright laws and international treaty provisions; therefore, you must treat the SOFTWARE like any other copyright material.

You may not use, copy, modify, reverse engineer or transfer this SOFTWARE except as expressly provided in the license. All rights not expressly granted are reserved by Thales and/or its suppliers.

* * *

No part of this guide may be reproduced or transmitted in any form or by any means, electronic or mechanical, including photocopying and recording, for any purpose other than the purchaser's personal use without the prior written permission of Thales.

* * *

Operation is subject to the following two conditions: (1) this device may not cause interference, and (2) this device must accept any interference, including interference that may cause undesired operation of the device.

© 2005 Thales Navigation, Inc. All rights reserved.

The Magellan Logo, Magellan, eXplorist and TrueFix are trademarks of Thales Navigation Inc.

631288-01 B

Table of Contents

eXplorist XL GPS Receiver	1
Features of the Magellan eXplorist GPS receiver:	1
Button Descriptions:	2
Installing the Batteries	3
Installing an Optional SD Card	4
Connecting to a Personal Computer	4
Starting Up	5
Turning the eXplorist On	5
Turning the eXplorist Off	5
Turning the Display Backlight On/Off	5
Using the eXplorist for the First Time	6
Conclusion	10
Using the eXplorist XL	11
Going to a Destination	11
Saving Your Position	12
Tracing Your Steps	13
Additional Features	13
Navigation Screens	14
Accessing the Navigation Screens	14
Map Screen	14
Map Screen Overview	15
Changing Map Scale	15
Map Screen Modes	15
Showing or Hiding Map Information	16
Customizing the Map Information	17
Displaying Street Information	18
Changing the Map Orientation	18
Changing the Primary Usage	19
Changing the Map Detail	19
Changing the Track Recording Intervals	20
Customizing the Display	20
Compass Screen	21
Compass Screen Overview	21
Customizing the Information Fields	22
Position Screen	23
Position Screen Overview	23
Resetting the Trip Odometer	24
Satellite Status Screen	24
Satellite Status Screen Overview	24
eXplorist XL GPS File Structure	25
Basic File Structure	25
File Structure Overview	25
Using the Filing System with POIs	26
Using the Filing System with Routes	26
Using the Filing System with Track Logs	27
Points of Interest	28
Marking Your Position	28
Marking Your Position (Personalized)	29
Making POIs for Locations other than your Present Position	30

Table of Contents

Marking a Position by Entering Coordinates	30
Marking a Position using the Map Cursor	31
Marking a Position from a Map Object	31
The POI Database	32
Searching for a User-Entered POI	32
Searching for a Preloaded POI using Nearest	33
Searching for a Preloaded POI using Alphabetical	33
Editing a User-Created POI	34
Deleting a User-Created POI	35
Viewing a User-Created POI on the Map Screen	35
Copying a Preloaded POI	36
Viewing a Preloaded POI on the Map Screen	37
Showing or Hiding a User-Entered POI on the Map Screen	38
Routes	39
GOTO Routes	39
Creating a GOTO Route	39
Creating a GOTO Route from the Map Cursor	40
Creating a GOTO Route to a Map Object	40
Multi-Leg Routes	41
Creating a Multi-leg Route	41
Activating/Deactivating a Route	42
Changing the Destination Leg of an Active Route	43
Editing a Saved Route	44
Reversing a Route	45
Deleting a Route	45
Moving a Route	46
Copying a Route	46
Viewing a Route on the Map	47
Track Logs	48
Track Logs	48
Stopping and Resuming Active Track Logging	48
Starting a New Active Track Log	49
Saving an Active Track Log	49
Creating a BackTrack Route	50
Clearing the Active Track	50
Converting the Track Log to a Route	51
Viewing the Track Log on the Map	51
Working with Saved Track Logs	52
Following Saved Track Logs	52
Reversing a Saved Track Log	52
Deleting a Saved Track Log	53
Moving a Saved Track Log	53
Copying a Saved Track Log	53
Advanced Features	54
Using Area Calculation	54
Deleting All POIs from the Area Calculation List	55
Editing the POI List in Area Calculation	55
Computing Best Fish/Hunt Times	55
Accessing Hunting and Fishing Times	55
Changing the Position	56
Changing the Date	56

Table of Contents

Displaying Sun and Moon Information	56
Accessing the Sun/Moon Function	56
Changing the Position	56
Changing the Date	57
Viewing the Vertical Profile	57
Using the Simulator	58
Simulating on a Saved Route	58
Communicating with a Personal Computer	59
Connecting to a Personal Computer	59
Changing Modes	59
Working with Files on the Personal Computer	60
Magellan Geocache Manager	61
Magellan Geocache Manager	61
What is Geocaching?	61
What is the Magellan Geocache Manager?	61
How Do I Install the Magellan Geocache Manager?	61
Using the Magellan Geocache Manager	62
Magellan Geocache Manager Tools	63
Working with Geocache Files	64
Adding Other Downloaded Files to the List	64
Uploading to the Magellan eXplorist	65
Using the eXplorist with MapSend	66
Using the eXplorist with MapSend	66
What is MapSend?	66
Overview of Uploading Detail Maps from MapSend to the eXplorist	66
Transferring POIs, Routes, and Track Between MapSend and eXplorist	69
Transferring POIs, Routes, and Tracks to MapSend	69
Transferring Waypoints, Routes, and Tracks from MapSend	70
Preferences	71
Restarting the GPS	71
Using Active Setup	73
Changing the Default Folders	73
Selecting the Background or Detail Map	74
Setting the Map Units	74
Selecting Navigational Units of Measure	74
Selecting the North Reference	75
Selecting the Coordinate System	75
Selecting the Map Datum	76
Using the Power Management Tool	76
Setting the Power Off Timer	76
Setting the Light Timer	77
Personalizing the eXplorist	77
Selecting Languages	78
Clearing Memory	78
Clearing Track History	78
Clearing User-Entered POIs and Routes	79
Clearing Routes	79
Clearing Active Track , User-Entered POIs and Routes	79
Resetting the eXplorist to Factory Defaults	80
Setting Alarms	80
Setting the Clock	81

Table of Contents

Setting the Time & Format	81
Setting Daylight Savings Time	82
Specifications	83
Performance	83
Physical	83
Power	84
Memory	84
Coordinate Systems	84
Routes	84
Track Logs	84
Points of Interest	85
Navigation Screens	85
Alarms	85
Accessories	86
Contacting Magellan Support	87
Contacting Magellan Support	87
Contacting Magellan in North America	87
Technical Support	87
Warranty Service	87
Contacting Magellan in Europe	88
Technical support and warranty service	88

Table of Contents

eXplorist XL GPS Receiver	1
Features of the Magellan eXplorist GPS receiver:	1
Button Descriptions:	2
Installing the Batteries	3
Installing an Optional SD Card	4
Connecting to a Personal Computer	4
Starting Up	5
Turning the eXplorist On	5
Turning the eXplorist Off	5
Turning the Display Backlight On/Off	5
Using the eXplorist for the First Time	6
Conclusion	10
Using the eXplorist XL	11
Going to a Destination	11
Saving Your Position	12
Tracing Your Steps	13
Additional Features	13
Navigation Screens	14
Accessing the Navigation Screens	14
Map Screen	14
Map Screen Overview	15
Changing Map Scale	15
Map Screen Modes	15
Showing or Hiding Map Information	16
Customizing the Map Information	17
Displaying Street Information	18
Changing the Map Orientation	18
Changing the Primary Usage	19
Changing the Map Detail	19
Changing the Track Recording Intervals	20
Customizing the Display	20
Compass Screen	21
Compass Screen Overview	21
Customizing the Information Fields	22
Position Screen	23
Position Screen Overview	23
Resetting the Trip Odometer	24
Satellite Status Screen	24
Satellite Status Screen Overview	24
eXplorist XL GPS File Structure	25
Basic File Structure	25
File Structure Overview	25
Using the Filing System with POIs	26
Using the Filing System with Routes	26
Using the Filing System with Track Logs	27
Points of Interest	28
Marking Your Position	28
Marking Your Position (Personalized)	29
Making POIs for Locations other than your Present Position	30

Table of Contents

Marking a Position by Entering Coordinates	30
Marking a Position using the Map Cursor	31
Marking a Position from a Map Object	31
The POI Database	32
Searching for a User-Entered POI	32
Searching for a Preloaded POI using Nearest	33
Searching for a Preloaded POI using Alphabetical	33
Editing a User-Created POI	34
Deleting a User-Created POI	35
Viewing a User-Created POI on the Map Screen	35
Copying a Preloaded POI	36
Viewing a Preloaded POI on the Map Screen	37
Showing or Hiding a User-Entered POI on the Map Screen	38
Routes	39
GOTO Routes	39
Creating a GOTO Route	39
Creating a GOTO Route from the Map Cursor	40
Creating a GOTO Route to a Map Object	40
Multi-Leg Routes	41
Creating a Multi-leg Route	41
Activating/Deactivating a Route	42
Changing the Destination Leg of an Active Route	43
Editing a Saved Route	44
Reversing a Route	45
Deleting a Route	45
Moving a Route	46
Copying a Route	46
Viewing a Route on the Map	47
Track Logs	48
Track Logs	48
Stopping and Resuming Active Track Logging	48
Starting a New Active Track Log	49
Saving an Active Track Log	49
Creating a BackTrack Route	50
Clearing the Active Track	50
Converting the Track Log to a Route	51
Viewing the Track Log on the Map	51
Working with Saved Track Logs	52
Following Saved Track Logs	52
Reversing a Saved Track Log	52
Deleting a Saved Track Log	53
Moving a Saved Track Log	53
Copying a Saved Track Log	53
Advanced Features	54
Using Area Calculation	54
Deleting All POIs from the Area Calculation List	55
Editing the POI List in Area Calculation	55
Computing Best Fish/Hunt Times	55
Accessing Hunting and Fishing Times	55
Changing the Position	56
Changing the Date	56

Table of Contents

Displaying Sun and Moon Information	56
Accessing the Sun/Moon Function	56
Changing the Date	57
Viewing the Vertical Profile	57
Using the Simulator	58
Simulating on a Saved Route	58
Communicating with a Personal Computer	59
Connecting to a Personal Computer	59
Changing Modes	59
Working with Files on the Personal Computer	60
Magellan Geocache Manager	61
Magellan Geocache Manager	61
What is Geocaching?	61
What is the Magellan Geocache Manager?	61
How Do I Install the Magellan Geocache Manager?	61
Using the Magellan Geocache Manager	62
Magellan Geocache Manager Tools	63
Working with Geocache Files	64
Adding Other Downloaded Files to the List	64
Uploading to the Magellan eXplorist	65
Using the eXplorist with MapSend	66
Using the eXplorist with MapSend	66
What is MapSend?	66
Overview of Uploading Detail Maps from MapSend to the eXplorist	66
Transferring POIs, Routes, and Track Between MapSend and eXplorist	69
Transferring POIs, Routes, and Tracks to MapSend	69
Transferring Waypoints, Routes, and Tracks from MapSend	70
Preferences	71
Restarting the GPS	71
Using Active Setup	73
Changing the Default Folders	73
Selecting the Background or Detail Map	74
Setting the Map Units	74
Selecting Navigational Units of Measure	74
Selecting the North Reference	75
Selecting the Coordinate System	75
Selecting the Map Datum	76
Using the Power Management Tool	76
Setting the Power Off Timer	76
Setting the Light Timer	77
Personalizing the eXplorist	77
Selecting Languages	78
Clearing Memory	78
Clearing Track History	78
Clearing Routes	79
Clearing Active Track , User-Entered POIs and Routes	79
Clearing User-Entered POIs and Routes	79
Resetting the eXplorist to Factory Defaults	80
Setting Alarms	80
Setting the Clock	81
Setting the Time & Format	81

Table of Contents







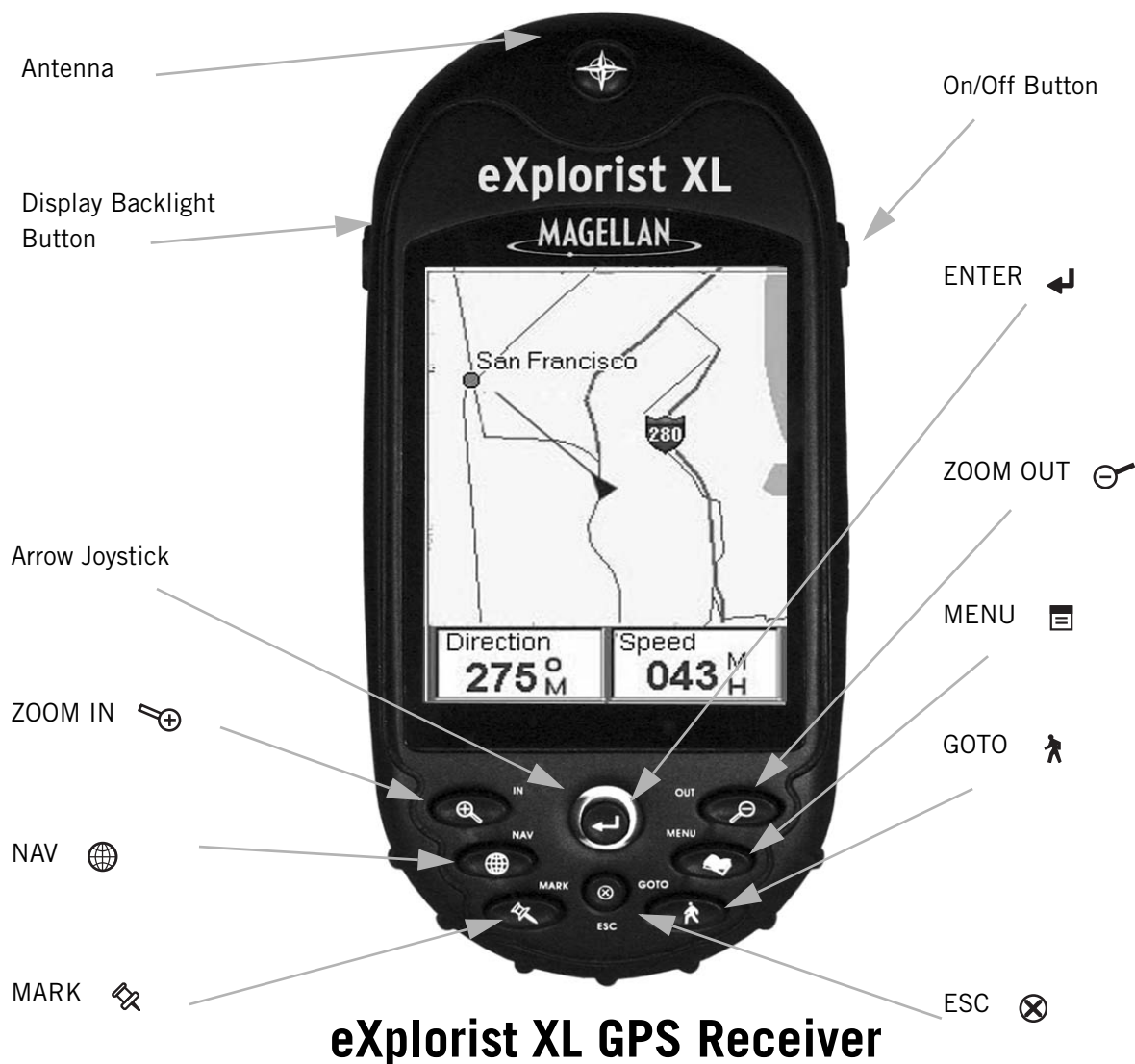

Setting Daylight Savings Time	82
Specifications	83
Performance	83
Physical	83
Power	84
Memory	84
Coordinate Systems	84
Routes	84
Track Logs	84
Points of Interest	85
Navigation Screens	85
Alarms	85
Accessories	86
Contacting Magellan Support	87
Contacting Magellan Support	87
Contacting Magellan in North America	87
Technical Support	87
Warranty Service	87
Contacting Magellan in Europe	88
Technical support and warranty service	88

Features of the Magellan eXplorist GPS receiver:

- Built-in background map (28 MB)
- High-definition color display
- Preloaded points of interest
- Rugged design, rubber-protected
- 28 MB of usable memory
- Superior tracking with 14 parallel channels
- TrueFix™ GPS technology
- 3 meter accuracy (WAAS/EGNOS)
- Multiple track logs
- Pocket-sized and water resistant
- Unlimited storage of data using SD cards



Button Descriptions:

On/Off		Turns the eXplorist on or off.
Backlight		Turns the display backlight on. Sequences from off to low to high intensity.
ENTER		Used to access highlighted menu items or accept highlighted buttons.
ESC		Cancels data inputs. Closes the accessed function and goes back to the last viewed screen. Steps backwards through the navigation screens.
ZOOM IN		Used on the Map screen to zoom in the map displayed. The map display can be zoomed in to 100 ft. (35.0 m). Also used to quickly step through the list of POIs when doing an alphabetical search.
ZOOM OUT		Used on the Map screen to zoom out the map displayed. The map display can be zoomed out to 1700 mi (2700 km). Also used to quickly step through the list of POIs when doing an alphabetical search.
MENU		Brings up a menu with available options. Options can be selected by using the arrow joystick to highlight the option and pressing ENTER to access it.
NAV		Steps through the navigation screens. (Map screen > Compass screen > Position screen > Satellite Status screen)
MARK		Used to save your present position as a point of interest. Points of interest that you save are stored in the <i>POIs</i> portion of the database.
GOTO		Creates a one-leg route from your present position to a destination selected from the Points of Interest database or by using the cursor on the background map
Arrow joystick		Pans the cursor on the Map screen. Moves the highlight bar to select menu options and data entry fields.

Installing the Batteries

Remove the battery cover by turning the silver latch on the back of the unit one quarter turn. The eXplorist XL uses four AA batteries that are installed as shown in the accompanying diagram. Be sure to observe the proper polarity when installing the batteries.

Under normal operating conditions you can expect to get more than 19 hours of battery life when using fresh batteries.

Tips on conserving battery life:

- Turn the eXplorist off when not in use. Whether you are moving or standing still, the eXplorist is constantly calculating position fixes and using power at the same rate. If you are going to be at the same position for any length of time, turn the eXplorist off.
- Use the Power Timer to automatically turn the eXplorist off. The Power Timer option allows you to set a time that the eXplorist will automatically turn off when none of the buttons have been pressed and you are not moving for a selected time. You can select from 5, 10, 30 or 60 minutes.
- Use the display backlight sparingly. The most severe drain on the batteries is the use of the display backlight. You will notice a drastic drop in battery life with the backlight display on high. You should use the Light Timer to set a time interval that the display backlight will automatically turn to the lowest setting when none of the buttons have been pressed and the computed location hasn't changed.

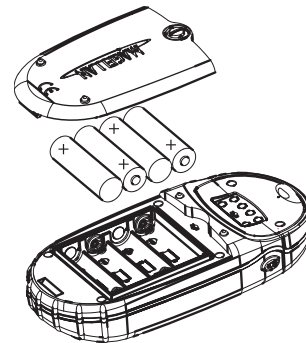

Setting the Power Timer

From any Nav screen press **MENU**. Highlight Preferences and press **ENTER**. Highlight Pwr Management and press **ENTER** twice. Use the arrow joystick to select 5 Minutes, 10 Minutes, 30 Minutes, 60 Minutes or Off. Press **ENTER**. Press **NAV** to return to the last viewed navigation screen.

Setting the Light Timer

From any NAV screen press **MENU**. Highlight Preferences and press **ENTER**. Highlight Pwr Management and press **ENTER**. Use the down arrow to highlight the Light Timer field. Press **ENTER**. Use the arrow joystick to select 30 Seconds, 1 Minute, 2 Minutes, 4 Minutes, 10 Minutes or Timer Off. Press **ENTER**. Press **NAV** to return to the last viewed navigation screen.

Installing an Optional SD Card

Install the SD card as shown here.

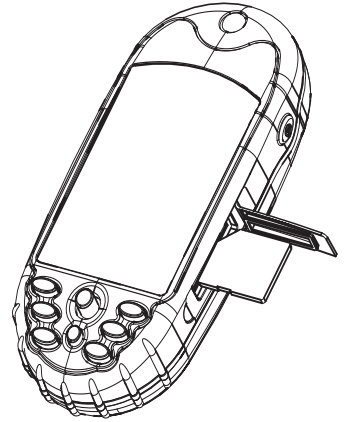

Connecting to a Personal Computer

Turn your eXplorist off and connect the connector of the eXplorist data cable to the back of your eXplorist and tighten the locking screw. There are alignment tabs on the connector to make sure that the connector is installed properly. It is recommended that you connect the eXplorist to external power using the external AC power adapter.

The other end of the eXplorist data cable has a standard USB connector that you connect to your personal computer USB ports (normally found on the back of your personal computer). Turn your personal computer on and then turn on your eXplorist. You may see a message on your computer indicating that it has found a new USB hardware device. On your eXplorist, a screen is displayed indicating that it is in USB File transfer mode.

Right click the "My Computer" icon on the desktop of your computer and select the "Explore" option. From here you are able to copy files to and from the eXplorist or SD card, depending upon what you have selected. From here you are able to copy files to and from the installed SD card to your computer.

WARNING: When connecting the USB cable, always connect it to the eXplorist first before plugging the AC power adapter into a wall socket.

Turning the eXplorist On

To turn the eXplorist on, press the **POWER** button on the top right side.

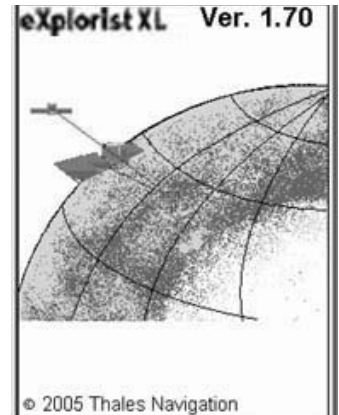

Turning the eXplorist Off

To turn the eXplorist off, press the **POWER** button on the top right side.

There is a 5 second countdown after you press the **POWER** button. If you change your mind and decide to leave the eXplorist on, just press the **ESC** button. If you press the **POWER** button during this countdown period, the eXplorist will immediately turn off.

**POWER DOWN
IN
4
SECONDS**

**PRESS
ESC KEY
TO CANCEL**

Turning the Display Backlight On/Off

The display backlight has three levels of intensity: low, high and off. When the eXplorist is first turned on, the display backlight is on low. Press the **LIGHT** button on the top left side of the eXplorist to turn the backlight off. Pressing the **LIGHT** button a second time turns the backlight on high.

Backlight intensity changes each time you press the **LIGHT** button.



Remember: Using the display backlight causes severe drain on the batteries.

Using the eXplorist for the First Time

Turn the eXplorist on. Press the **Power** button. When the *Startup* screen is displayed, press **ENTER**.

Select Language. When you turn on the eXplorist for the first time you are given the option of selecting one of the ten languages that will be used.

You can change the language selection at any time by accessing Menu > Preferences > Languages.

Tip: If you accidentally change the language and you can't read the text and need to change it back, press the **NAV** button until the Satellite Status screen is displayed. Press **MENU**. Use the **Arrow** joystick to highlight the fifth line and press **ENTER**. Use the **Arrow** joystick to highlight the sixth line and press **ENTER**. The Language Select screen will be displayed.

Read Warning. When you agree to the warning statement, press **ENTER** to continue.

Compute Initial Position. For this operation, it is best if you are outside and have a clear, unobstructed view of the sky. Without a clear view, this will take much longer and could result in the eXplorist being unable to compute the initial position automatically.

The eXplorist begins to compute your initial position. This may take a few minutes as it is doing a *cold start*.

Normally, when you first turn the eXplorist on it will compute your position in a manner of seconds as it is able to do a *warm start*. (An explanation of *cold start* vs. *warm start* is explained following this section.)

The *Satellite Status* screen is displayed, showing you the progress of the collection of satellite data.



Use arrow joystick to move the highlight up and down. Press **ENTER** to accept.



Press **ENTER** to continue.

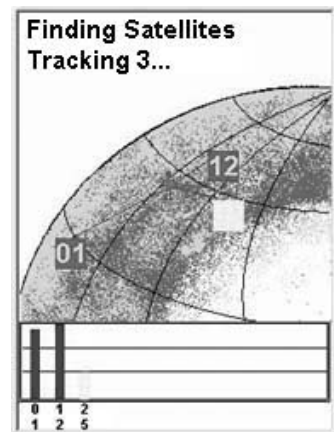

Satellite Status screen shows how many satellites are being tracked as well as the relative strength of the signal.

The *Satellite Status* screen will continuously update and you will be able to graphically see how well your eXplorist is performing.

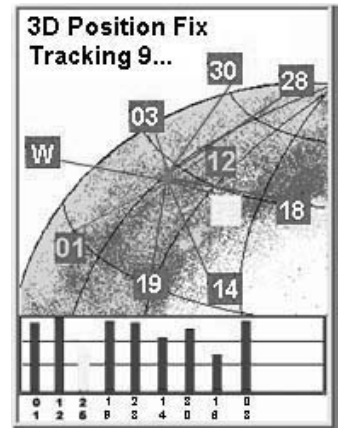

When the eXplorist has enough information to compute a position fix, the *Satellite Status* screen is replaced with the *Map* screen. The arrow cursor in the center of the *Map* screen represents your position. As you move, the arrow will point in the direction you are traveling.

Tip: Use the **ZOOM IN** and **ZOOM OUT** buttons to change the map scale to better see your present position.



If the eXplorist is unable to compute your initial fix in a few minutes: If the eXplorist determines that it is unable to track the satellites within two minutes, it will present you with the following screens in an effort to better determine its approximate location.

Select Region. Use the arrow joystick to highlight the region that you are located in. With the region highlighted, press the **ENTER** button.



Select Area. This displays a list of areas for the region you selected. Use the arrow joystick to highlight the area that applies to you and press the **ENTER** button.



Enter Current Time. Use the arrow joystick to enter the current time.

Arrow Joystick Up: Increases the highlighted number

Arrow Joystick Down: Decreases the highlighted number

Arrow Joystick Right: Moves the highlight one character to the right

Arrow Joystick Left: Moves the highlight one character to the left

Toggle between AM and PM by moving the arrow joystick up or down when AM or PM is highlighted.

When you have entered the correct time, press **ENTER**.

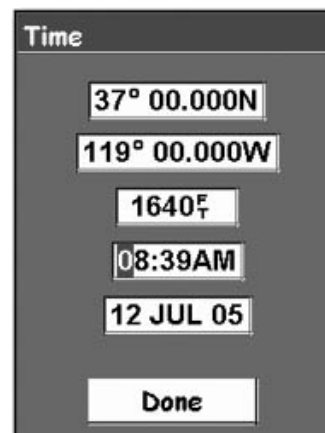

The latitude and longitude that represents the center of the region and area you selected is displayed.

Enter the Date. Use the arrow joystick to set the date displayed to the current date.

Arrow Joystick Up: Increases the highlighted number

Arrow Joystick Down: Decreases the highlighted number

Arrow Joystick Right: Moves the highlight one character to the right

Arrow Joystick Left: Moves the highlight one character to the left

When the month is highlighted, use the arrow joystick up or down to scroll through the list of months.

When you have entered the correct date, press **ENTER**.

Accept Information. The **Done** button is highlighted at the bottom of the display. Review the information you entered and if correct press **ENTER**.

Tip: If the time or the date is incorrect, you can fix them now. Use the arrow joystick to highlight the time or date field that you want to fix. With the field highlighted, press **ENTER**. You can now change the information using the same technique used before.

The *Satellite Status* screen is displayed again and the eXplorist will try to compute your position using the information you just provided.

Tip: If you notice that the satellite signal strength bars are still not changing, try moving to a new location where you have a clearer view of the sky.

As before, when the eXplorist computes the initial position, the *Map* screen will be displayed with your computed position indicated by the arrow cursor in the middle of the display.

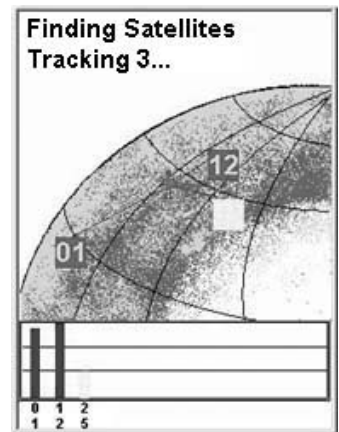
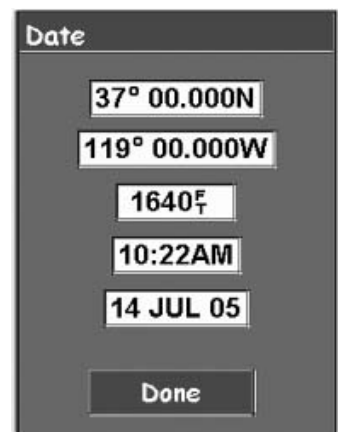
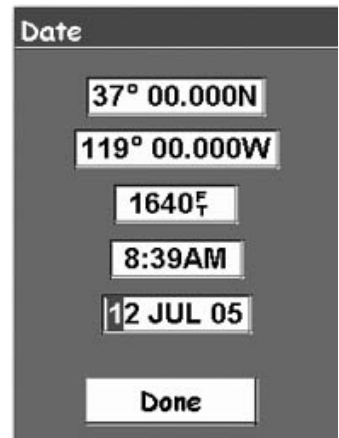

Cold vs. Warm Start. When the eXplorist is turned on, one of the first things it does is to find out what satellites are overhead, along with their relative position. It does this by using a built-in satellite almanac. This almanac, when given the current date, time and approximate position, can provide the eXplorist with information on what satellites are overhead and their approximate relationship to the eXplorist. Now with information on satellite availability, the eXplorist can begin setting its internal satellite channels to receive satellite transmissions.

Cold Start. Cold start is defined as when the eXplorist does not have an approximate position to use when referring to its almanac. This can occur when:

- The eXplorist is turned on for the first time after purchase. The memory is cleared prior to shipping so any position that may have been in the eXplorist is set to a null value.
- If you have cleared the eXplorist's memory, (found in **Preferences**) all of the memory will be cleared and the last computed position will be set to a null value.
- If you have traveled with your eXplorist turned off, the last position saved may be so far away that when the eXplorist begins looking for satellites, the satellites it is expecting to find are not there. (As a rule of thumb, any time you move more than 500 mi [804.7 km] with the eXplorist turned off, there is a good chance it will start up using a cold start.

A cold start should take no more than 2-3 minutes to compute the initial position fix.

Warm Start. Warm starts are when the last position calculated before the eXplorist was turned off is still in memory and you are in the same approximate position. Most of the time the eXplorist is turned on, it will be in its warm start mode. With a clear view of the sky, the eXplorist should compute its position in a matter of seconds.

Conclusion

This concludes the initial startup procedure for the Magellan eXplorist XL. Once the *Map* screen is displayed, you have successfully initialized the eXplorist and are ready to go.

Now would be a good time to familiarize yourself with the different navigation screens (using the **NAV** button) and to set any preferences that may be different from the factory defaults.

The eXplorist XL uses information from the GPS satellites orbiting the earth to provide you with detailed information about your exact location. This is the foundation that your eXplorist will use to provide you with the necessary information to arrive at your destination.

Going to a Destination

The most common use of your eXplorist will be to provide you with the navigation tools you'll need to arrive at your chosen destination. The simplest route, and the one used most, is a GOTO route. This is a route that is computed as a straight line from where you are to where you want to go.

Step One: Compute Your Position

The basic operation of your eXplorist is to use the GPS satellites to compute your present position. This is done internally in the software of your eXplorist. The only thing that you need to do is to give your eXplorist a clear view of the sky so that it can receive the signals from the satellites.

Do:

- Point the antenna up towards the sky. (For antenna location see “Features of the Magellan eXplorist GPS receiver:” on page 1.)
- Maintain a clear view of the sky.

Don't:

- Cover the antenna with your hand or other objects.
- Point the antenna down.
- Stand under trees or other heavy foliage.
- Stand where the satellite signals are being blocked by large obstructions (such as buildings, in a narrow canyon, etc.)

If you find that the eXplorist is not computing a position, just move to a place that has a better view of the sky.

Anytime you want to view the status of the satellites and their signal strength, switch to the Satellite Status screen. Here you will graphically see the satellites and their relative signal strength. You need at least three satellites with good signal strength (indicated by green bars) to compute your position. A computed position with only three satellites is termed a 2D position fix. When you are getting a 2D position fix, your elevation is not being computed. To add elevation to your position fix, you need at least four satellites with good signal strength. Positions that use four or more satellites are called 3D position fixes.

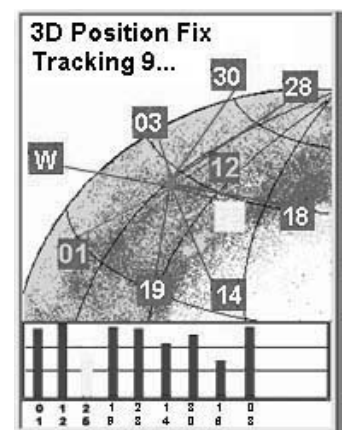

Step Two: Where Do You Want To Go?

Now that the eXplorist knows where you are, you need to tell it where you want to go. There are many different ways you can do this, but the simplest and most commonly used is a “GOTO” route. This is a one-leg route with a beginning (where you are now) and a destination (where you want to go). The destination is selected by using the *Points of Interest* database. This database has two main options; positions you have saved (*POIs*) or points of interest that have been preloaded into your eXplorist (*Background Map*).

Creating a GOTO route is as simple as pressing the **GOTO** button and selecting the destination from the points of interest database.

Step Three: Calculating Movement

As you move, your eXplorist is constantly calculating new positions, comparing the new position to the previous position and calculating such things as heading and speed. This is all done in the eXplorist’s software communicating with the satellites and is instantaneously shown on your display.

Step Four: Providing Directions

Your eXplorist constantly computes a direct line from your present position to your destination. From that it will provide you instructions to guide you along that straight path. Unless you are on a large body of water, it will be unlikely that you will be able to follow these instructions exactly. To compensate for that, your eXplorist automatically updates the route, providing you with up-to-date information about getting to your destination.

GOTO routes are the simplest and most commonly used feature of your eXplorist XL. With just the **GOTO** button the eXplorist will provide you with the tools needed to get to any point of interest stored in your database.

Saving Your Position

Another commonly used feature of the eXplorist is saving your position to the Points of Interest database. This feature is accessed by pressing the **MARK** button. When saving your position, you can also add attributes like a selected icon or a name for the point of interest. This will help you find this spot in the future when accessing it from the points of interest database.

Suppose you have set up camp for the night. Tomorrow you plan on doing some nature exploring and you want to be able to come back to the campsite when you are done. Press the **MARK** button and set the name of the point of interest to “Camp”. After your hiking is done, simply use the **GOTO** button and select “Camp” from the list of *POIs*. It’s that simple to find your way back.

While out fishing on the lake, you come across the perfect spot for catching your limit. Next year you want to be able to come back to this very same spot. Turn on your eXplorist and after it has computed your position, press the **MARK** button to save it. This time you can enter the name “Catfish1” and save your point of interest. Next year you can be back at the same hot spot with just a press of the **GOTO** button.

A simpler example, and one you can do just about any time, is finding your car in that ocean of other cars in the shopping mall parking lot. Just park your car, step outside and let your eXplorist compute your position. (Make sure that you have a clear view of the sky.) Using the **MARK** button, save this position with the name “Car”. When you are done shopping, just go outside the mall and create a GOTO with the destination “Car”. No matter where you parked, your eXplorist will guide you back, simply and easily.

Tracing Your Steps

Hikers, mountain bikers and outdoor enthusiasts often need the option of leaving a trail of breadcrumbs that they can follow back to where they started. The eXplorist has a feature called *BackTrack* that enables you to do just that.

It was mentioned earlier that your eXplorist is constantly computing your present position and that you can save your position by using the **MARK** button. Now imagine that your eXplorist automatically saved your computed positions as you moved along the trail. Pretty soon there would be a set of saved positions, like breadcrumbs, that represents the trail you have taken. This is exactly what the eXplorist does. It saves the computed positions as hidden points of interest and strings them together to represent your travels. This is called your *Track* and the hidden points of interest are your *Track Log*.

What your eXplorist enables you to do, is to use this Track, reverse it and navigate you along the same path you followed to get you back to your destination.

You might drive to the ranger station and follow the trail that leads you to the waterfalls you have been wanting to see. With your eXplorist turned on and able to compute position fixes, you continue along the trail. The trail winds along and has many smaller trails attached to it and as the day progresses you arrive at the falls. When it's time to head back to your car, you access your Track Logs list and select the *Active Track* log. Now press **MENU**, highlight BackTrack and press **ENTER**. Your eXplorist will now seamlessly guide you along the path, tracing your footsteps, back to where you started.

Another nice feature of Track Logs that you may find useful, is that you are able to save the Track Logs and recall them at any time. In the above example, when you were at the waterfall, you could save that track and use it anytime you wanted to go back again.

Additional Features

Your Magellan eXplorist contains all the features you would expect from a high-quality Magellan brand handheld navigation device as well as many more to make your outdoor experience more enjoyable. You have the ability to customize the navigation screens, enabling you to view the information that is important to you. The eXplorist makes full use of the Map screens enabling you to graphically see your position, the route you are navigating on, the path that you have trekked (Track), as well as points of interest icons. There is a built-in odometer so you can log the length of your journey. User preferences enable you to set up and maintain your eXplorist so that it fits your needs and requirements. The eXplorist gives you all of this and more in an easy-to-use, portable navigation tool that includes built-in help files that you can access in the great outdoors.

Accessing the Navigation Screens

The eXplorist has three navigation screens as well as a *Satellite Status* screen that can be accessed by pressing the **NAV** button. Each screen provides the same information in a different format giving you the choice of choosing the screen that best suits your needs.

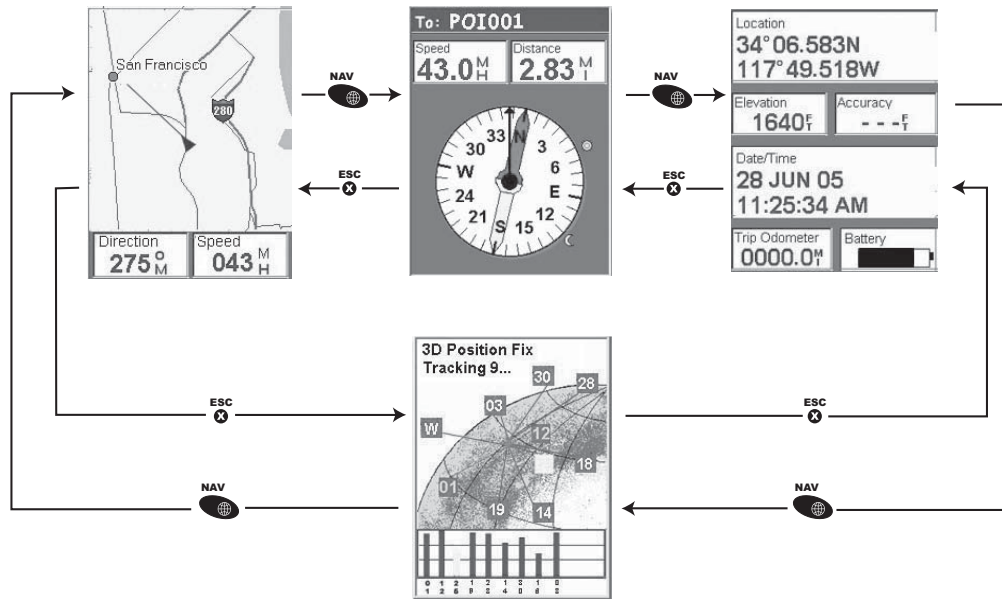

Tip: The **ESC** button will also set through the navigation screens, just like the **NAV** button but in the reverse order.

Map Screen

The first, and most commonly used screen is the *Map* screen. The *Map* screen displays your position, as well as POI's and any background map data for the area displayed.

Highlights of the *Map* screen:

- Use the zoom in/out buttons to change the scale.
- The arrow cursor in the middle of the display indicates your position, and if moving, points in the direction you are heading.
- Press **MARK** to save your position.
- Use the **Arrow** joystick to move the cursor. The arrow cursor changes to a crosshair cursor with any available information about the position of the cursor at the bottom of the display. You can also save the position of the crosshair cursor as a POI by pressing the **MARK** button.
- Press **ESC** when you are done panning with the crosshair cursor to display your present position with the arrow cursor.
- Press **MENU** and select **Hide Map Info** or **Show Map Info** to turn the information boxes at the bottom of the screen on or off.

- Press **MENU** and select **Customize page** to change the information displayed at the bottom of the screen.
- Press **MENU** and select **Map Setup** to change the orientation of the screen as well as the primary usage (land or marine).

Map Screen Overview

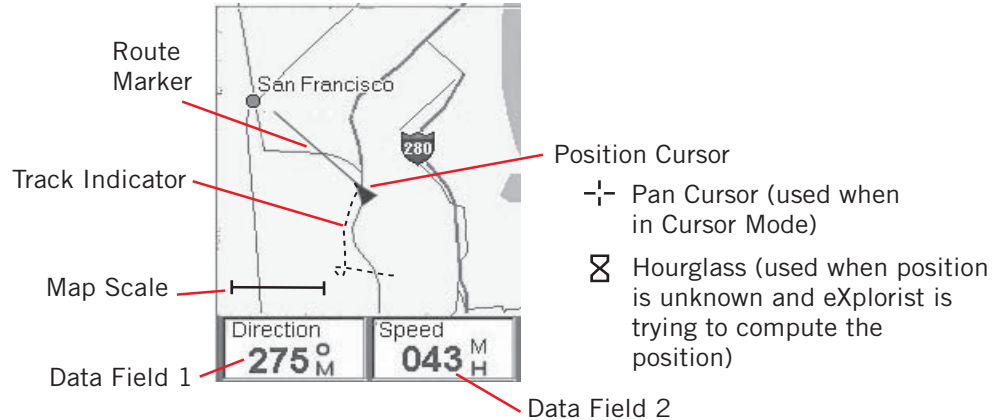

Changing Map Scale

Press the **Zoom In** or the **Zoom Out** buttons to change how much of the map is displayed on the screen. The map scale indicator in the bottom left corner of the map indicates the relative distance between the two end-points of the scale. The scale can be changed from 1700 mi (2700 km) to 100 ft. (35.0 m).

Tip: Press and hold the **Zoom In** or the **Zoom Out** buttons to rapidly step through the map scales.

Map Screen Modes

The *Map* screen has two modes that it can be in, position or cursor. In the Position mode the Map screen displays your position, indicated by the arrow icon in the center of the map. The arrow not only displays your position but, when moving, will point in the direction you are heading.

The Position mode is the default mode for the Map screen. Whenever you enter the Map screen it will be in the Position mode.



The Map screen in the Position Mode.

In the Cursor mode, you have a cursor icon displayed that you can use to pan around the map. The information displayed at the bottom of the screen provide you with the heading and distance the cursor is at from your present position. In the Cursor mode you can:

- scroll around the map, seeing available information for areas on the map not displayed around your present position,
- create a POI for the position indicated by the cursor,
- create a GOTO route to the position indicated by the cursor location, or
- get detailed information about POI's or map objects found at the cursor location.

These options will be explained in the section of this manual on creating POI's and GOTO routes.

To enter the Cursor mode, use the **Arrow** joystick to move the cursor. As soon as the joystick is moved, a crosshair cursor is displayed and the bottom of the screen changes to provide information about the cursor position.

To exit the cursor mode, press the **ESC** button. When pressed, the *Map* screen is returned to the Position mode, with your present position displayed in the center of the screen.

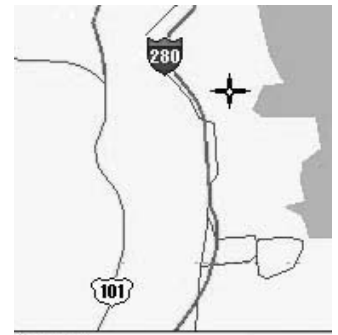

Cursor
61° M 55.4 M I
The Map screen in the
Cursor Mode.

Showing or Hiding Map Information

The information at the bottom of the *Map* screen provides you with information that can be used to assist you in navigating to your destination. However, you may want to display more of the map and do not need this information. The eXplorist gives you the capability to turn this information on or off.

1. While viewing the *Map* screen, press **MENU**.
2. With **Hide Map Info** or **Show Map Info** highlighted, press **ENTER**.



The Map screen with map information shown.

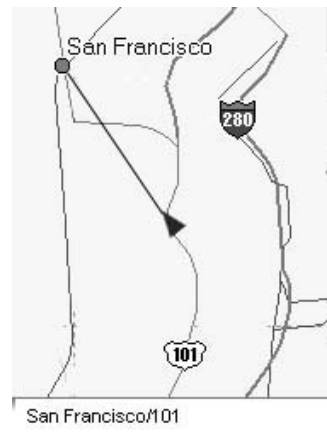

The Map screen with map information hidden.

Customizing the Map Information

The information displayed at the bottom of the screen can be customized to change what is shown in the two map information fields. You can select from:

- Bearing
- Distance to Next (Next leg in multi-leg routes)
- Distance to End
- Speed [default]
- Heading [default]
- ETA (Estimated Time of Arrival)
- Time to Next (Next leg in multi-leg routes)
- Time to End
- Off Course
- Direction
- Elevation
- Time
- Date
- Accuracy
- Avg. Speed
- Max. Speed

To customize the map information:

1. While viewing the *Map* screen, press **MENU**.
2. Use the **Arrow** joystick to highlight **Customize page**.
3. Press **ENTER**.
4. Use the Arrow joystick to highlight **Two Data Fields**.
5. Press **ENTER**.
6. The title bar for one of the fields is highlighted. Use the **Arrow** joystick to highlight the title bar for the field you want to customize.
7. Press **ENTER**.
8. Highlight the information you want displayed from the list.
9. Press **ENTER**.
10. The highlight will automatically jump to the other field. Go back to step 5 to change the information displayed for this field.
11. When the information to be displayed is chosen, press **ESC** to exit the customize function.

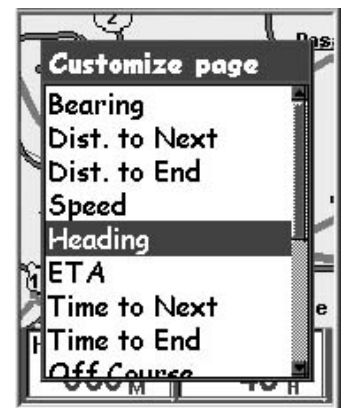

Displaying Street Information

You can choose to display information about the street you are on instead of displaying the two data fields at the bottom of the display.

To display street information:

1. While viewing the *Map* screen, press **MENU**.
2. Use the Arrow joystick to highlight **Customize page**.
3. Press **ENTER**.
4. Use the Arrow joystick to highlight **Street info**.
5. Press **ENTER**.

Changing the Map Orientation

The default orientation for the *Map* screen is North Up. This means that the top of the display represents true north. This orientation can be changed so that the top of the display is more useful to you. You can choose from:

- North Up. [default] This orientates the top of the map display to represent true north.
- Course Up. In course up, the top of the map displays the direction to your destination. (When there is not an active route, the top of the display indicates true north.)
- Track Up. In track up, the top of the map display changes to reflect your heading. (If you are not moving, the top of the display indicates true north.)

Note: In Course Up and Track Up, a north indicator is displayed in the upper right corner of the display. This arrow points in the direction of true north.

To change the map orientation:

1. While viewing the *Map* screen, press **MENU**.
2. Use the **Arrow** joystick to highlight **Map Setup**.
3. Press **ENTER**.
4. Use the **Arrow** joystick to highlight the Orientation field.
5. Press **ENTER**.
6. Use the **Arrow** joystick to highlight **North Up**, **Course Up** or **Track Up**.
7. Press **ENTER**.
8. Press **NAV** to return to the *Map* screen.

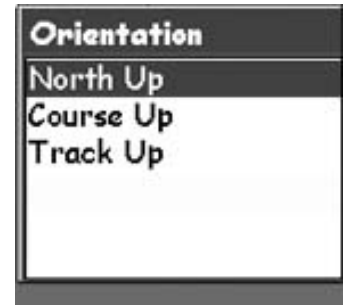

Changing the Primary Usage

The *Map* screen can be changed to be primarily used on land (default) or marine. When in land usage, land areas are displayed as white areas on the display and water is displayed as blue. When set for marine usage, water is blue and land areas are displayed as yellow.

This option provides the ability to view the text and map details easier, depending on where you are navigating.

To change the primary usage:

1. While viewing the *Map* screen, press **MENU**.
2. Use the **Arrow** joystick to highlight **Map Setup**.
3. Press **ENTER**.
4. Use the **Arrow** joystick to highlight the Primary Usage field.
5. Press **ENTER**.
6. Use the **Arrow** joystick to highlight **Marine** or **Land**.
7. Press **ENTER**.
8. Press **NAV** to return to the *Map* screen.

Changing the Map Detail

The Map screen can be modified to show varying levels of map detail. This can be useful while viewing very dense areas of the map where some of the fine details may not be needed and clutter the display.

To change the map detail:

1. While viewing the *Map* screen, press **MENU**.
2. Use the **Arrow** joystick to highlight **Map Setup**.
3. Press **ENTER**.
4. Use the **Arrow** joystick to highlight the Detail field.
5. Press **ENTER**.
6. Use the **Arrow** joystick to highlight **Lowest**, **Low**, **Medium**, **High** or **Highest**.
7. Press **ENTER**.
8. Press **NAV** to return to the *Map* screen.

Changing the Track Recording Intervals

As you move, your eXplorist is recording your journey (track). You can select how often the track points are recorded. In Auto mode, the eXplorist doesn't save track points when you are traveling in a straight line and only a few as you make turns. This saves memory and provides a track log that, while slightly jagged, is suitable for most applications. In Detailed Auto mode, the eXplorist does the same as in Auto mode, but the frequency of track points saved is increased, especially during turns. While this uses more memory, it provides a very accurate log of your travels. The other options are fixed interval track points. This instructs your eXplorist to record a track point at the interval you specify.

To change the track recording intervals:

1. While viewing the *Map* screen, press **MENU**.
2. Use the **Arrow** joystick to highlight **Map Setup**.
3. Press **ENTER**.
4. Use the **Arrow** joystick to highlight the Track Mode field.
5. Press **ENTER**.
6. Use the Arrow joystick to highlight **Off**, **Auto**, **Auto Detailed** or any of the fixed distance intervals.
7. Press **ENTER**.
8. Press **NAV** to return to the *Map* screen.

Customizing the Display

You can select what items are displayed on the Map screen. This can reduce clutter and/or emphasize those items you are interested in.

To customize the display:

1. While viewing the *Map* screen, press **MENU**.
2. Use the **Arrow** joystick to highlight **Map Setup**.
3. Press **ENTER**.
4. Push the **Arrow** joystick right to highlight the Display tab.
5. Push the **Arrow** joystick up or down to highlight the item you want to toggle on or off.
6. Press **ENTER**.
Mark All toggles all of the map items on, while **Clear All** toggles all of the map items off. When an item has a check mark next to it, it will be displayed on the *Map* screen.
7. Press **NAV** to return to the *Map* screen when you have the desired settings.

Compass Screen

The *Compass* screen provides an easy-to-use graphical compass that should be familiar to most GPS users.

Highlights of the *Compass* screen:

- With an active route, the top of the Compass screen displays the name of the destination.
- Press **MENU** and select **Customize page** to change the information displayed at the top of the screen.
- When there is no active route, the graphical compass performs like a standard compass, indicating your heading referenced to true north. (Note you must be moving at least 0.5 mph for the compass to display heading information.)
- With an active route, the compass graphically displays an icon representing your destination.

Compass Screen Overview

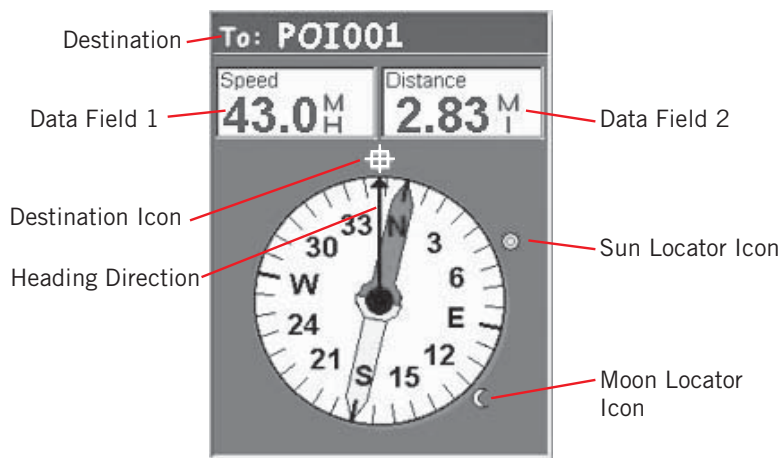

The top of the screen (the header bar) displays the name of the destination if you have an active route. Without an active route, the destination name is blank.

Also, two navigation information fields (customizable) are displayed.

When there is an active route, an icon representing the destination is displayed outside the compass. When the destination icon is at the top of the compass, you are moving in the direction of your destination. If there is not an active route, the destination icon will not be present.

The heading direction arrow always points to the top of the compass indicating the direction of travel or last computed heading if you are not moving. The compass arrow always points North.

Customizing the Information Fields

The information displayed at the top of the screen can be customized to information important to you. You can select from:

- Bearing
- Distance to Next (Next leg in multi-leg routes) [default]
- Distance to End
- Speed [default]
- Heading
- ETA (Estimated Time of Arrival)
- Time to Next (Next leg in multi-leg routes)
- Time to End
- Off Course
- Direction
- Elevation
- Time
- Date
- Accuracy
- Avg. Speed
- Max. Speed

To customize the map information:

1. While viewing the *Compass* screen, press **MENU**.
2. Use the **Arrow** joystick to highlight **Customize page**.
3. Press **ENTER**.
4. The title bar for one of the fields is highlighted. Use the **Arrow** joystick to highlight the title bar for the field you want to customize.
5. Press **ENTER**.
6. Highlight the information you want displayed from the list.
7. Press **ENTER**.
8. The highlight will automatically jump to the other field. Go back to step 5 to change the information displayed for this field.
9. When the information to be displayed is chosen, press **ESC** to exit the customize function.



Position Screen

The *Position* screen provides detailed position information in a text format that is familiar to seasoned navigators.

Highlights of the *Position* screen:

- Position is displayed in textual format using the coordinate system selected. (See *Setting Coordinate System for information on how to select the coordinate system.*)
- Elevation information is displayed. (Accurate when four or more satellites are being used to compute the position.)
- Computed accuracy of the position computed is displayed. WAAS is also displayed in the Accuracy field when the eXplorist is using WAAS information to increase the accuracy of the position fix.
- Date and time are shown, automatically adjusted from time information supplied from the atomic clocks in the GPS satellites.
- A resettable trip odometer to keep track of the distance you've travelled.
- A graphical battery indicator provides you with information on the current condition of the AA batteries in the eXplorist.

Position Screen Overview

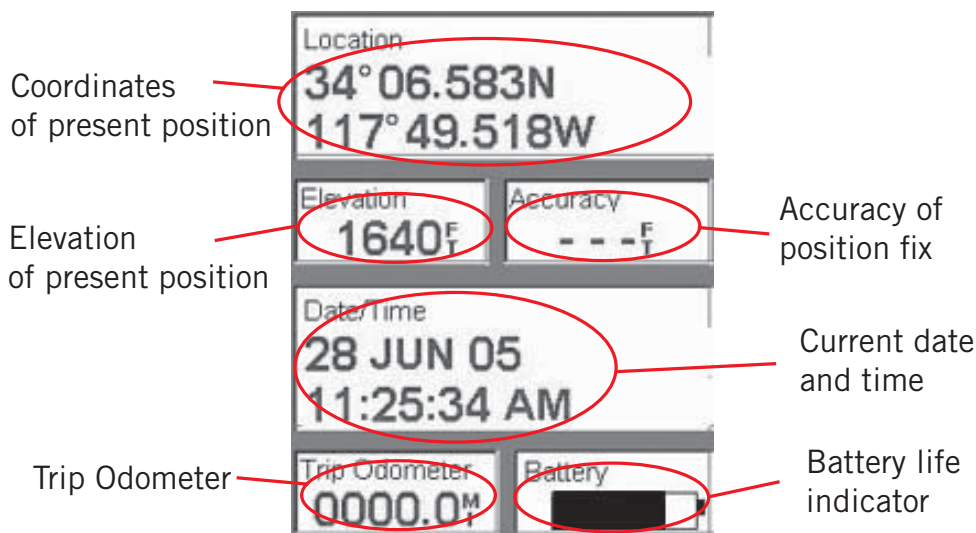

Resetting the Trip Odometer

Whenever you begin a trip that you want to record how far you have travelled, you will want to reset the trip odometer to zero.

To reset the trip odometer:

1. While viewing the *Position* screen, press **MENU**.
2. Use the **Arrow** joystick to highlight **Reset Trip**.
3. Press **ENTER**.
4. Use the **Arrow** joystick to highlight **Yes**.
5. Press **ENTER**.



Warning page offers you the opportunity to change your mind.

Satellite Status Screen

The *Satellite Status* screen is a handy way to visually see just how well the eXplorist is tracking and receiving satellite signals.

Highlights of the *Satellite Status* screen:

- Type of position fix as well as the number of satellites being tracked is displayed. [2D Position Fix requires three satellites; a 3D Position Fix requires four satellites or more.]
- Graphical indication of the location of the satellites, as well as their assigned number identifiers, are shown.

Bar chart supplies information as to the signal strength for each satellite. [A yellow bar indicates that the satellite is being tracked but has not been locked on yet, a green bar indicates that the satellite has been locked on. You may see two signal strength bars with no label. These indicate signal strength of the two WAAS satellites.

Satellite Status Screen Overview

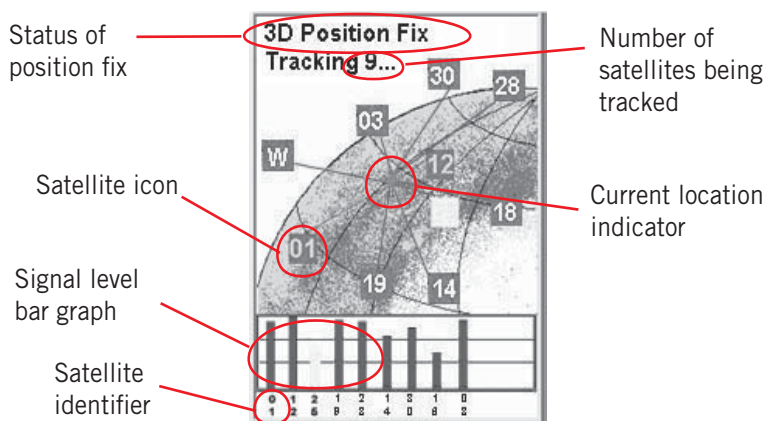

Basic File Structure

The eXplorist has a file structure system that is unlike any other filing system used before on a GPS receiver. It is based on the file system that you are probably familiar with from using your personal computer.

File Structure Overview

This graphic displays the basic layout of the file structure that is internal to the eXplorist. When you insert a new SD card, a similar file structure is created but without any of the default files.

While it is possible to save files in any of the folders (i.e., POIs could be saved in the Routes folder), it is highly recommended that you create new files in the associated main topic folder. This will make finding the POI or route much easier when you need to access the file.

The Detail Maps and Geocaches folders are empty until you upload a detailed map from mapping software, such as Magellan MapSend or geocache files from the Magellan Geocaching software.

The files for POIs, routes, track logs and geocaching points are ASCII text files. When your eXplorist or SD card is connected to your personal computer, you can open these files using any text editor and modify them to your needs. If you are going to modify any of the files, you should do so to a copy of the file. Mistakes in modifying the files can cause unwanted results.

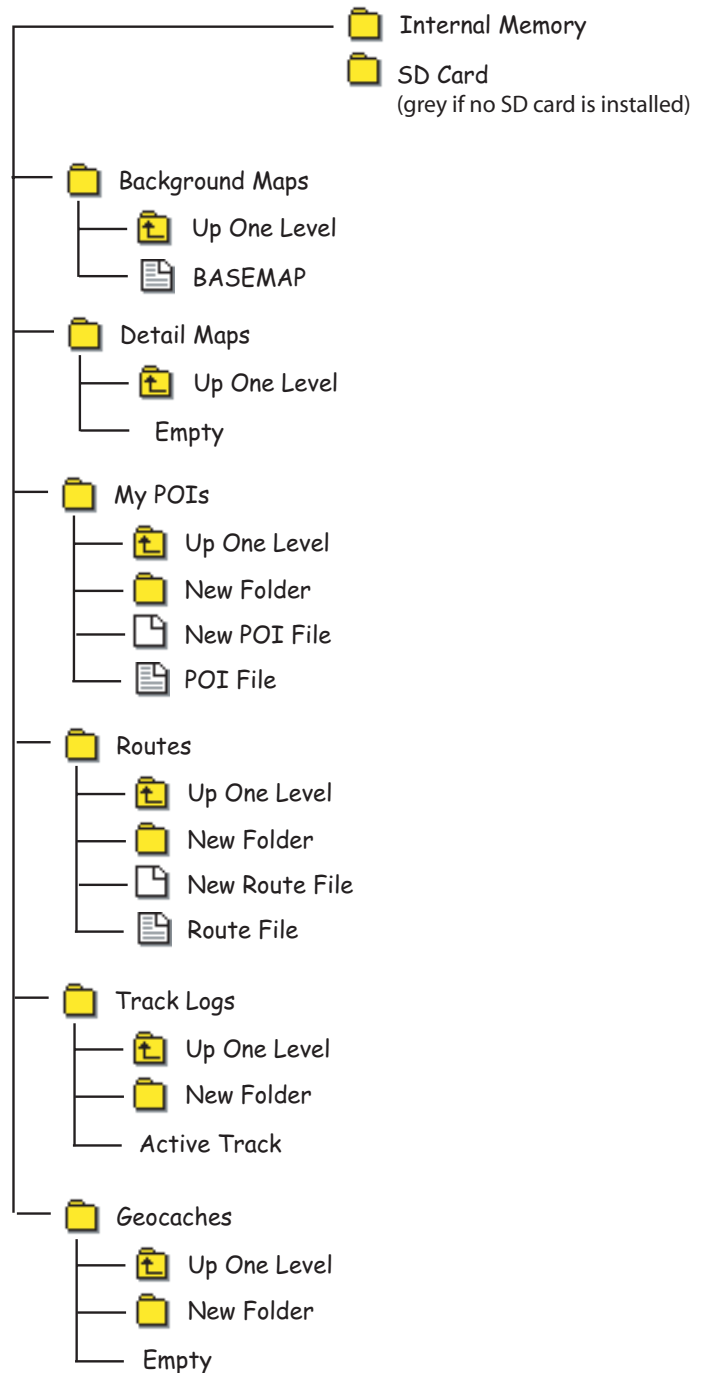

Using the Filing System with POIs

- When retrieving or saving a POI, the eXplorist automatically saves the POI to the default POI file. You can select the location to save the POI, by choosing Save As when creating a file.

NOTE: The default file is set at the factory but you can change the default file to be used by accessing Preferences > Active Setup.

- Creating a new POI File: If you want to save the POI to a unique file, perhaps a file devoted to this trip, Use the **Arrow** joystick to highlight **New POI File** and press **ENTER**. Use the displayed keyboard to enter a name for the file. When the name is correct, highlight **OK** and press **ENTER**. The POI you are saving will automatically be stored in the new file and you will be returned to the last viewed *Map* screen.
- Creating new Folders: You can also create new folders for your POI files to be saved in. Use the **Arrow** joystick to highlight **New Folder** and press **ENTER**.

Use the displayed keyboard to enter a name for the folder. When the name is correct, highlight **OK** and press **ENTER**. The new folder is now highlighted. Press **ENTER** to access this folder. Since there isn't any POI files in this folder, you will need to use the **New POI File** option to create a new file before you can add any POIs.

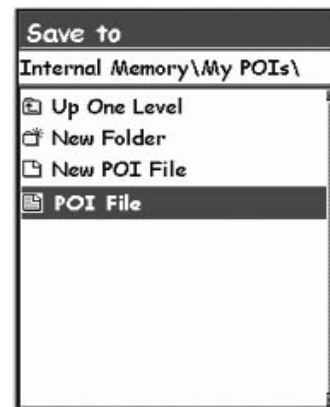

Using the Filing System with Routes

- When retrieving or saving a route, the eXplorist automatically save the route in the default file. You may save the route in a different location by using the Save As option.

NOTE: Once you have created a new route file, you can set it to be the default route by accessing Preferences > Active Setup.

- Creating a new Route File: Exit the file you have open by using the **Up One Level** option. Use the **Arrow** joystick to highlight **New Route File** and press **ENTER**.

Use the displayed keyboard to enter a name for the route file. When the name is correct, highlight **OK** and press **ENTER**. The new route file is displayed and highlighted, ready for you to save a route in it.

- Creating new Folders: You can also create new folders for your route files to be saved in. Exit the file you have open by using the **Up One Level** option. Use the **Arrow** joystick to highlight **New Folder** and press **ENTER**.

Use the displayed keyboard to enter a name for the folder. When the name is correct, highlight **OK** and press **ENTER**. The new folder is now highlighted. Press **ENTER** to access this folder. Since there isn't any route files in this folder, you will need to use the **New Route File** option to create a new file before you can add a route.

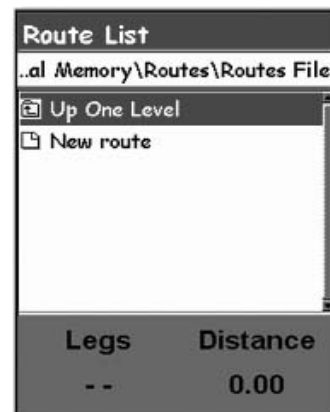

Using the Filing System with Track Logs

- Track logs are saved differently from POIs and routes in that there is only one track log per file. Also, you can't set a default file for track logs. The eXplorist automatically accesses the internal Tracklog folder.
- Creating a new Track Log File: Use the **Arrow** joystick to highlight **Active Track** and press **ENTER**. Use the **Arrow** joystick to highlight **Save** and press **ENTER**. If you want you can now browse through the file structure to find the folder you want to save the track log in. When you have selected the desired location, highlight **Save in here** and press **ENTER**.

Use the displayed keyboard to enter a name for the track log file. When the name is correct, highlight **OK** and press **ENTER**. The track log you are saving will automatically be stored in the new file and you will be returned to the last viewed *Map* screen.

- **Creating new Folders:** You can also create new folders for your track log files to be saved in. Use the **Arrow** joystick to highlight **New Folder** and press **ENTER**. (The **New Folder** option is displayed only when you are saving your active track.)

Use the displayed keyboard to enter a name for the folder. When the name is correct, highlight **OK** and press **ENTER**. The new folder is now highlighted. Press **ENTER** to access this folder.

During the instruction portions of this manual, instructions will not describe all of the things you can do within the file system. When an instruction is given to save a POI, details about creating new folders, new files, etc. will be omitted.



Whether driving in a car, hiking on the trail or out for an afternoon sail, you are going to want to save places you've been in your eXplorist so you can go back to them in the future. This is the fundamental starting point for any GPS navigator.

Saving these places is called "Marking your position" or just MARK for short. The saved positions are called points of interest, or just POI's. (You may have heard the term "waypoints" to describe marked positions. Waypoints and points of interest are identical.)

There are four types of POIs available for your eXplorist XL: POIs that you have marked (saved), POIs that have been stored in your eXplorist as part of the built-in background map, POIs that have been uploaded using the geocaching software, and POIs that have been uploaded from a detailed map. These POIs are accessed from the same MENU option and can be used independently or combined to create routes.

Marking Your Position

The most common way of adding POI's to the database will be marking your present position. There are two levels of marking your position. The first that will be described will be quick marking your position. The second method provides you the means to personalize POI's you are saving.

Quick Marking Your Position

This saves your present position in the database using mark position defaults.

1. Press **MARK**.
2. Press **ENTER**.

Note: if a position fix is not being computed or if only a 2D position fix (no elevation information) is being computed, a warning will be displayed asking you to confirm that you still want to save this position.

When you save a 2D position fix you will notice that even though elevation was not computed, that a elevation value is included as part of the POI. This elevation is the last elevation that was computed by the eXplorist.

Tip: Later in this manual you will see a way to modify the icon, name and message of positions you have quick marked.



Sample Mark Screen

Marking Your Position (Personalized)

Normally, marking your position is simply a two button process, **MARK** and **ENTER**. However, sometimes you will want to personalize the POI you are marking to make it easier to identify later. You are able to change the icon, change the name, and create a message. (You are also able to change the location coordinates as well as the elevation. This changes the position that is being saved and is discussed in a following section.

1. Press **MARK**.
2. Use the **Arrow** joystick to highlight the field you want to change.
3. Press **ENTER**.
- 4a. If the icon field was selected: Use the **Arrow** joystick to select the icon desired and press **ENTER**. To aid in your selection, the type of icon selected is displayed in the information block at the top of the keypad.
- 4b. If the Name field was selected. Use the **Arrow** joystick to select the character desired and press **ENTER**. If you make a mistake, highlight **Back** and press **ENTER**. To access the lower case characters, highlight **Shift** and press **ENTER**. To clear everything and start over, highlight **CLEAR** and press **ENTER**. When you are satisfied with the name, highlight **OK** and press **ENTER**.

Note: User saved POI names can only be eight characters long (including spaces).

- 4c. If the Message field was selected. Use the keypad displayed just as was described in 4b to enter a message for this POI. Message fields can have up to 30 characters, including spaces.
5. When the Icon, Name and Message fields are done, use the Arrow joystick to highlight **Save**.
6. Press **ENTER**.



The screenshot shows a 'Mark' screen with the following fields and controls:

- Vis:** A checked checkbox.
- Icon:** A field containing a hash symbol (#).
- Name:** A field containing 'POI004'.
- Location:** A field containing '34° 06.583N' and '117° 49.518W'.
- Elevation:** A field containing '1640'.
- Message:** A field containing 'CREATE MESSAGE?'.
- Buttons:** 'Save', 'Save As', and 'Cancel'.

Mark Screen with Name field highlighted.

Making POIs for Locations other than your Present Position

Sometimes you may want to save a position that is not your present position. The eXplorist offers you two ways of doing that. You can modify the coordinates of your present position or you can use the Cursor mode of the *Map* screen to pan to the location you want to mark.

Marking a Position by Entering Coordinates

This method of marking a position would normally be used when you have gotten the coordinates for the position from a map or chart. It is also possible that you have gotten the coordinates from a friend and want to save this POI in your eXplorist database.

Before beginning, make sure that your eXplorist has been set to use the same coordinate system that the coordinates you plan on entering are in. If not, you will have to go to Preferences and change the coordinate system used by your eXplorist.

1. Press **MARK**.
2. Use the **Arrow** joystick to highlight the Location field.
3. Press **ENTER**.
4. Depending on the coordinate system used, the information will be different but the process is the same. Use the **Arrow** joystick in an up/down motion to increase or decrease the value at the cursor point. To move the cursor point left or right, use the **Arrow** joystick in a left/right motion.
Input the data on the first line of the Location field. When done, press **ENTER** and the cursor will drop to the second line. Continue inputting the data for the second line of the Location field.
5. Press **ENTER**.
6. Use the **Arrow** joystick to highlight **Save**.
7. Press **ENTER** to save the new POI.

Note: While not described here, you can change the icon, name, elevation and add a message just as described in *Marking Your Position (Personalized)*.



Entering new position coordinates.

Marking a Position using the Map Cursor

This gives you a way of marking a position, other than your present position, by moving the cursor around the map to a place you want to create a POI.

1. While viewing the *Map* screen, use the **Arrow** joystick to put the eXplorist into Cursor mode.
2. Continue moving the crosshair cursor until you are over the location where you want to add a POI.
3. Press **MARK**.
4. *Optional:* Use the **Arrow** joystick to highlight fields (icon, name, etc.) of the POI that you want to edit. When you are done editing the field, press **ENTER**.
5. With **Save** highlighted, press **ENTER**.
6. Press **ESC** to exit the Cursor mode and return to the Position mode.

Marking a Position from a Map Object

Another method of marking a position while in the Cursor mode, is to use the crosshair cursor to mark a map object (road, city, etc.).

1. While viewing the *Map* screen, use the **Arrow** joystick to put the eXplorist into Cursor mode.
2. Continue moving the crosshair cursor until you are over a map object you want to add as a POI. (The information about the map object will be displayed at the bottom of the display.)
3. Press **ENTER**.
4. Use the **Arrow** joystick to select from the list of map objects for that location the one you want to use as the baseline for the new POI.
5. Press **ENTER**.
6. The **Save** option will be highlighted.
7. Press **ENTER**.
8. *Optional:* Use the **Arrow** joystick to highlight fields (icon, name, etc.) of the POI that you want to edit. When you are done editing the field, press **ENTER**.
9. With **Save** highlighted, press **ENTER**.
10. Press **ESC** to exit the Cursor mode and return to the Position mode.

The POI Database

All of the POI's that you have saved as well as background map POI's that came with your eXplorist can be accessed using the POI database. Once the database has been accessed and the POI selected you can view or edit the POI.

Highlights of the POI database are:

- Searching for POI's you have saved, nearest to your position or in alphabetical order.
- Searching for POI's that have been preloaded into the eXplorist, nearest to your position or in alphabetical order.
- Ability to edit POI's you have saved.
- Ability to delete POI's you have saved.
- Function letting you view a POI (one's you have saved or preloaded) on the map.
- Provides another means to save a preloaded POI as a user-entered POI.
- While viewing the list of POI's, the bearing and distance from your present position is displayed at the bottom of the screen.

Searching for a User-Entered POI

When searching for a POI that you have entered, you have two options to choose from, nearest or alphabetical.

1. Press **MENU**.
2. Use the **Arrow** joystick to highlight **POI List**.
3. Press **ENTER**.
4. Use the **Arrow** joystick in an up/down motion to highlight **POIs**.
5. Use the **Arrow** joystick in a left/right motion to select **Nearest** or **Alphabetical**.
6. Press **ENTER**.
If **Nearest** is selected, indicate if you want a list of POIs that are nearest to your position, a city you will select, or another POI you will select from the POI database.
7. Locate the file where the POI has been saved and press **ENTER**. (The eXplorist will automatically open the default file.)
8. Highlight the POI and press **ENTER**.

From here you can edit, delete or view on the map the POI you have highlighted by pressing **ENTER** and selected the desired function from the menu. Detailed information on these functions can be found later in this manual.



POI database set to search for user-entered POIs by Nearest.

Searching for a Preloaded POI using Nearest

Searching for a preloaded POI using the Nearest option is similar to searching for user-entered POI's with an additional step. Preloaded POI's have been categorized into five categories (Cities, Highways, Airports, Waterways and Parks) and you need to select the category that the POI will be found in.

1. Press **MENU**.
2. Use the **Arrow** joystick to highlight **POI List**.
3. Press **ENTER**.
4. Use the **Arrow** joystick in an up/down motion to highlight **Background Map**. Press **ENTER**.
5. Use the **Arrow** joystick in a left/right motion to select **Nearest**.
6. Press **ENTER**.
7. Use the **Arrow** joystick to select **Position** (POIs nearest to your present position), **Cities** (POIs nearest to a city you will select), or **Other** (POIs nearest to another POI you will select from the database).
8. Press **ENTER**.
9. Use the **Arrow** joystick to highlight the category (**Cities**, **Highways**, **Airports**, **Waterways**, or **Parks**) for the POI.
10. Press **ENTER**.
11. Use the **Arrow** joystick to highlight the POI desired and press **ENTER**

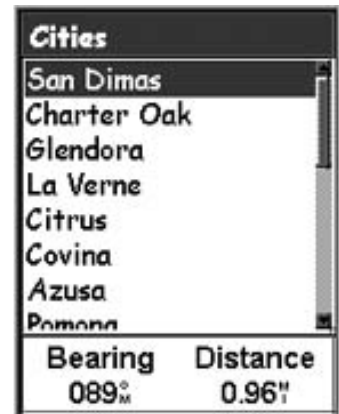

List of cities nearest to the present position.

Searching for a Preloaded POI using Alphabetical

This is very similar to searching for a POI using nearest but due to the large numbers of POI's in the database, an additional step has been added to help you find the POI you are looking for quicker.

1. Press **MENU**.
2. Use the **Arrow** joystick to highlight **POI List**.
3. Press **ENTER**.
4. Use the **Arrow** joystick in an up/down motion to highlight **Background Map**.
5. Use the **Arrow** joystick in a left/right motion to select **Alphabetical**.
6. Press **ENTER**.
7. Use the **Arrow** joystick to highlight the category, (**Cities**, **Highways**, **Airports**, **Waterways** or **Parks**) for the POI.
8. Press **ENTER**.
9. Use the **Arrow** joystick and the **ENTER** button to enter the first few characters of the POI you are searching for. (Five characters is usually enough to put you close enough on the list to the POI you are looking for.)
10. Use the **Arrow** joystick to highlight **OK**.
11. Press **ENTER**.
12. Use the **Arrow** joystick to highlight the POI desired.



Keyboard used to narrow the search.

From here you can copy or view on the map the POI you have highlighted by pressing **ENTER** and selected the desired function from the menu. Detailed information on these functions can be found later in this manual.

Editing a User-Created POI

POI's that you have saved can be edited to change the icon, name, elevation and message. You can also change the location but keep in mind that this effectively is creating a new POI in a new location.

1. Press **MENU**.
 2. Use the **Arrow** joystick to highlight **POI List**.
 3. Press **ENTER**.
 4. Use the **Arrow** joystick up/down to highlight **POIs**.
 5. Use the **Arrow** joystick left/right to select **Nearest** or **Alphabetical**.
 6. Press **ENTER**.
 7. Locate the file where the POI has been saved and press **ENTER**. (The eXplorist will automatically open the default file.)
 8. Use the **Arrow** joystick to highlight the POI to be edited and press **ENTER**.
 9. Use the **Arrow** joystick to highlight **Edit POI**.
 10. Press **ENTER**.
 11. Use the **Arrow** joystick to highlight the field you want to change.
 12. Press **ENTER**.
 - 13a. If the icon field was selected: Use the **Arrow** joystick to select the icon desired and press **ENTER**. To aid in your selection, the type of icon selected is displayed in the information block at the top of the keypad.
 - 13b. If the Name field was selected. Use the **Arrow** joystick to select the character desired and press **ENTER**. If you make a mistake, highlight **Back** and press **ENTER**. To access the lower case characters, highlight **Shift** and press **ENTER**. To clear everything and start over, highlight **CLEAR** and press **ENTER**. When you are satisfied with the name, highlight **OK** and press **ENTER**.
- Note:* User-entered POI names can be up to 20 characters long (including spaces).
- 13c. If the Message field was selected. Use the keypad displayed just as was described in 13b to enter a message for this POI.
 - 13d. If the Vis (Visibility) field is selected: Press **ENTER**. Select **On** or **Off** and Press **ENTER**.
 14. When the Icon, Name and Message fields are done, use the **Arrow** joystick to highlight **Save**.
 15. Press **ENTER**.

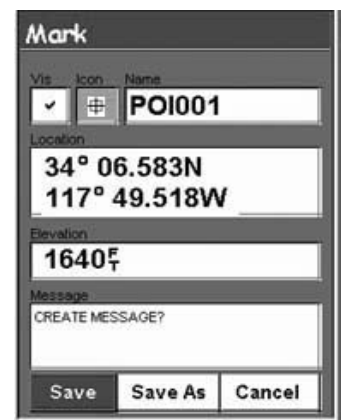

Editing an existing POI with the icon field highlighted.

Deleting a User-Created POI

POI's that you have saved can be deleted using this operation. You may want to delete a POI to make it easier to search for a POI you created if you have a lot of them.

POI's that have been deleted cannot be restored. You will need to input the information for a POI you delete if you want it back. To prevent accidental deletion, a confirmation window will be displayed, confirming the delete.

1. Press **MENU**.
2. Use the **Arrow** joystick to highlight **POI List**.
3. Press **ENTER**.
4. Use the **Arrow** joystick up/down to highlight **POIs**.
5. Use the **Arrow** joystick left/right to select **Nearest** or **Alphabetical**.
6. Press **ENTER**.
7. Locate the file where the POI to be deleted has been saved and press **ENTER**. (The eXplorist will automatically open the default file.)
8. Highlight the POI and press **ENTER**.
9. Use the **Arrow** joystick to highlight **Delete POI** and press **ENTER**.
10. Confirm the deletion by highlighting **Yes**, or cancel the deletion by highlighting **No**.
11. Press **ENTER**.

Viewing a User-Created POI on the Map Screen

POI's that you have saved can be viewed on the Map screen to assist you in locating the POI.

1. Press **MENU**.
2. Use the **Arrow** joystick to highlight **POI List**.
3. Press **ENTER**.
4. Use the **Arrow** joystick up/down to highlight **POIs**.
5. Use the **Arrow** joystick left/right to select **Nearest** or **Alphabetical**.
6. Press **ENTER**.
7. Locate the file where the POI has been saved and press **ENTER**. (The eXplorist will automatically open the default file.)
8. Highlight the POI and press **ENTER**.
9. Use the **Arrow** joystick to highlight **View on Map**.
10. Press **ENTER**.
11. The *Map* screen will be displayed in the Cursor mode. The cursor will be directly over the POI you have selected. You may use the **Zoom** buttons to change the scale of the map displayed and if your position icon is within range, it will be shown.
12. Press **ESC** to return to the list of POI's found in step 7.

Note: Remember that pressing the **NAV** button will return you to the last viewed *Map* screen. In step 12 if you are finished with the POI's in the POI database, you could press **NAV** to close the POI database and return to the last viewed *Map* screen.

Copying a Preloaded POI

POI's that have been preloaded as part of the background map can be saved as a user-entered POI. This does not delete a preloaded POI (preloaded POI's can not be deleted) it just copies it to the **POIs** portion of the database.

1. Press **MENU**.
2. Use the **Arrow** joystick to highlight **POI List**.
3. Press **ENTER**.
4. Use the **Arrow** joystick up/down to highlight **Background Map**.
5. Use the **Arrow** joystick left/right to select **Nearest** or **Alphabetical**.
6. Press **ENTER**.
7. Select a category of your choice and press **ENTER**.
8. [If Alphabetical search is selected] Use the **Arrow** joystick and the **ENTER** button to enter the first few characters of the POI you are searching for. Highlight **OK** and press **ENTER** to continue.
[If Nearest to current location is selected] Choose **Position**, **Cities**, **Cursor** or **Other**. Then press **ENTER**.
9. Use the **Arrow** joystick to highlight the POI to be copied.
10. Select **Save** and press **ENTER**.

Steps 10 through 12 are optional.

11. Use the **Arrow** joystick to highlight the field you want to change.
12. Press **ENTER**.
- 12a. If the icon field was selected: Use the **Arrow** joystick to select the icon desired and press **ENTER**. To aid in your selection, the type of icon selected is displayed in the information block at the top of the keypad.
- 12b. If the Name field was selected. Use the **Arrow** joystick to select the character desired and press **ENTER**. If you make a mistake, highlight **Back** and press **ENTER**. To access the lower case characters, highlight **Shift** and press **ENTER**. To clear everything and start over, highlight **CLEAR** and press **ENTER**. When you are satisfied with the name, highlight **OK** and press **ENTER**.

Note: User-entered POI names can be up to 20 characters long (including spaces).

- 12c. If the Message field was selected. Use the keypad displayed just as was described in 13b to enter a message for this POI.
13. When the Icon, Name and Message fields are done, use the **Arrow** joystick to highlight **Save**.
14. Press **ENTER**.

Viewing a Preloaded POI on the Map Screen

POI's that have been preloaded as part of the background map can be viewed on the *Map* screen to assist you in locating the POI.

1. Press **MENU**.
2. Use the **Arrow** joystick to highlight **POI List**.
3. Press **ENTER**.
4. Use the **Arrow** joystick up/down to highlight **Background Map**.
5. Use the **Arrow** joystick left/right to select **Nearest** or **Alphabetical**.
6. Press **ENTER**.
7. Select a category of your choice and press **ENTER**.
8. [If Alphabetical search is selected] Use the **Arrow** joystick and the **ENTER** button to enter the first few characters of the POI you are searching for. Highlight **OK** and press **ENTER** to continue.
[If Nearest to current location is selected] Choose **Position**, **Cities**, **Cursor** or **Other**. Then press **ENTER**.
9. Use the **Arrow** joystick to highlight the POI to be viewed.
10. Use the **Arrow** joystick to highlight **View**.
11. Press **ENTER**.
12. The *Map* screen will be displayed in the Cursor mode. The cursor will be directly over the POI you have selected. You may use the **Zoom** buttons to change the scale of the map displayed and if your position icon is within range, it will be shown.
13. Press **ESC** to return to the detail screen of POI's found in step 8.

Note: Remember that pressing the **NAV** button will return you to the last viewed *Map* screen. In step 13 if you are finished with the POI's in the POI database, you could press **NAV** to close the POI database and return to the last viewed *Map* screen.

Showing or Hiding a User-Entered POI on the Map Screen

You can select whether a user-entered POI is displayed or hidden while viewing the *Map* screen. In the upper left corner of the POI Save screen (next to the icon field) is a checkbox that indicated if the POI will be visible on the map. When it is checked, the POI is visible.

The instructions here describe how to toggle the visible state of a saved POI, but the same steps can be followed while you are creating a new POI.

1. Press **MENU**.
2. Use the **Arrow** joystick to highlight **POI List**.
3. Press **ENTER**.
4. Use the **Arrow** joystick up/down to highlight **POIs**.
5. Press **ENTER**.
6. Locate the file where the POI has been saved and press **ENTER**. (The eXplorist will automatically open the default file.)
7. Highlight the POI and press **ENTER**.
8. Use the **Arrow** joystick to highlight **Edit POI**.
9. Press **ENTER**.
10. Use the **Arrow** joystick to highlight the **Vis** field.
11. Press **ENTER**.
12. Highlight **On** or **Off** and press **ENTER**.
13. Use the **Arrow** joystick to highlight **Save**.
14. Press **ENTER**.

Routes are the least understood and one of the most important functions of a GPS receiver. The better you understand routes and how to use them, the more enjoyment you will receive from using your eXplorist.

The easiest, and most common form of a route is a *GOTO* route. A GOTO route is a one-leg route with a starting point (your present position) and a destination (a POI you select). This route is useful when you want to go to a specific preloaded or user-entered POI.

The next type of a route is a *multi-leg route*. The easiest way to understand multi-leg routes is they are GOTO routes stuck together. If a GOTO route is from A to B then a multi-leg route goes from A to B, B to C, C to D and so on. (Using the term multi-leg is somewhat misleading as it can be a single leg route but these types of routes are rarely used as a one-leg route, a GOTO route would be used instead.) An advantage of a multi-leg route is that it can be saved in the eXplorist's memory to be activated and used over and over.

A third type of route is a *backtrack* route. (The creation of backtrack routes are not described in this section of the manual as they are part of the Track Log functions of the eXplorist.) As you travel the eXplorist records your track. Creating a backtrack route uses this track information and creates a multi-leg route, in reverse order, enabling you to navigate back to where you started.

GOTO Routes

A GOTO route is the most commonly used form of route in your eXplorist. The creation of a GOTO route is no harder than pressing the **GOTO** button and searching in the POI database for the destination POI.

Features of a GOTO route:

- A straight line from your present position to a selected POI.
- GOTO routes can not be saved.
- GOTO routes are erased when the eXplorist is turned off.
- GOTO routes can be created by pressing the **GOTO** button and selecting the destination POI from the POI database.
- GOTO routes can also be created in the Cursor mode of the *Map* screen.

Creating a GOTO Route

The instructions here describe the most common, and easiest way to create a GOTO route.

1. Press **GOTO**.
2. Use the POI database to select the POI to be the destination.

Note: Detailed instructions for searching the POI database can be found in the Points of Interest section of this manual.

3. With the POI highlighted, press **ENTER**.
4. If you already have a GOTO you will be asked to confirm the creation of this GOTO.

After pressing ENTER, the last viewed navigation screen will be displayed, updated as needed to provide information about the GOTO route you have created. On the Map screen, a line will be drawn representing the GOTO route. The Compass screen will change to display the name of the POI used as the destination in the screen header bar and an icon representing the destination outside the diameter of the compass.

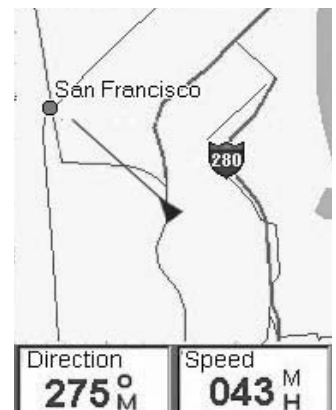

The Map screen in the Position Mode.

As you are moving you will notice a second line appearing that points to your destination if you go off the planned course. The double solid line is the original, computed route. The new, dashed line is an updated route, pointing towards your destination. So even if you can't follow the computed route, you will be updated with a new course to follow. This updating of your route will also occur during multi-leg routes so you always know which way you need to go.

Creating a GOTO Route from the Map Cursor

This will create a GOTO route to a point on the map that you have indicated by moving the crosshair cursor on the *Map* screen.

1. While viewing the *Map* screen, use the **Arrow** joystick causing the eXplorist to go into Cursor mode.
2. Continue using the **Arrow** joystick to move the crosshair cursor to a point on the map that represents where you want to go to.
3. Press **GOTO**.
4. If a GOTO is active, you will be asked to deactivate it and create a new GOTO route. Highlight **Yes** and press **ENTER** to overwrite the existing GOTO. You are then asked if you want to create a new GOTO route. Highlight **Yes** and press **ENTER**.
5. Confirm that you want to create a GOTO from the current cursor position. Highlight **Yes**.
(If you highlight **No** and press **ENTER**, the eXplorist assumes that you still want to create a GOTO, just not to the current cursor position. The POI database screen will be displayed so you can search the database for the POI you want to use as the destination.)
6. Press **ENTER**.

After pressing **ENTER**, the last viewed navigation screen will be displayed, updated as needed to provide information about the GOTO route you have created. On the *Map* screen, a line will be drawn representing the GOTO route. The *Compass* screen will change to display the name of the POI used as the destination in the screen header bar and an icon representing the destination outside the compass diameter.

Creating a GOTO Route to a Map Object

This will create a GOTO route to a map object (city, highway, user POI, etc.) that you have indicated by moving the crosshair cursor on the *Map* screen over the map object.

1. While viewing the *Map* screen, use the **Arrow** joystick causing the eXplorist to go into Cursor mode.
2. Continue using the **Arrow** joystick to move the crosshair cursor to the map object that you want to go to.
3. Press **ENTER**.
4. Use the **Arrow** joystick to highlight the map object that you want to use as the GOTO. (Some areas of the map may have multiple map objects in the same location.)
5. Press **ENTER**.
6. Use the **Arrow** joystick to highlight **Goto**.
7. Press **ENTER**.
8. If a GOTO is active, you will be asked to deactivate it and create a new GOTO route. Highlight **Yes** and press **ENTER**.

After pressing **ENTER**, the last viewed navigation screen will be displayed, updated as needed to provide information about the GOTO route you have created. On the *Map* screen, a line will be drawn representing the GOTO route. The *Compass* screen will change to display the name of the POI used as the destination in the screen header bar and an icon representing the destination outside the compass diameter.

Multi-Leg Routes

Multi-leg routes can be used to navigate to a final destination using multiple legs. An example would be leaving the dock, motoring over to buoy 1, then the bait boat and finally to a fishing hot spot. This route would go from Dock to Buoy 1, Buoy 1 to Bait, Bait to Fish.

Features of a multi-leg route:

- Multi-leg routes can be saved in internal memory or to an SD card.
- Multi-leg routes remain active even after the eXplorist has been turned off.
- Multi-leg routes can be edited, reversed, deleted or viewed on the map.
- When a multi-leg route is active, you can switch which leg will be used as the next destination point. In the above example, you could skip going to Buoy 1 by selecting the Bait leg when the route is active.

Creating a Multi-leg Route

The eXplorist will provide you an empty list for your route and you can use the POI's saved in the POI database to create the route. All the tools you'd need to create the route will be described here.

Steps in creating a multi-leg route:

1. Press **MENU**.
2. Use the **Arrow** joystick to highlight **Routes**.
3. Press **ENTER**.
4. Use the **Arrow** joystick to highlight **<New route>**.
5. Press **ENTER**.
6. **Add POI** is highlighted. Press **ENTER**.
7. The POI database is shown. Search the database for the POI you want to use as the starting POI for the route.
8. Continue pressing **ENTER** with **Add POI** highlighted. Select the next POI for the route from the POI database.
9. *Optional:* As you are creating the route you may want to edit what you have already entered. You can insert, delete or replace a POI that is already in the route list.

Inserting: Use the **Arrow** joystick to highlight the POI that you want to insert a new leg before. Press **MENU**, highlight **Insert POI** and press **ENTER**. Search the POI database for the new POI. The new POI will be added inserting into the route you are creating.

Deleting: Use the **Arrow** joystick to highlight the POI you want to delete from the route. Press **MENU**, highlight **Delete POI** and press **ENTER**.

Replacing: Use the **Arrow** joystick to highlight the POI you want to replace. Press **MENU**, highlight **Replace POI** and press **ENTER**. Search the POI database for the new POI. The POI you select will replace the POI that was originally highlighted.

10. When you have added all of the legs to the route you are creating, use the **Arrow** joystick to highlight **Save**.



Create Route screen

11. Press **ENTER**.
12. Use the **Arrow** joystick and the **ENTER** button to input a name, up to ten characters, for the route.
13. Highlight **OK**.
14. Press **ENTER**.

Activating/Deactivating a Route

An active route is the route you are presently navigating on. Anytime you activate a route, it will remain the active route until you either turn it off (deactivate) or activate a new route. GOTO's are automatically activated when they are created while multi-leg routes need to be activated manually.

1. Press **MENU**.
2. Use the **Arrow** joystick to highlight **Routes**.
3. Press **ENTER**.
4. Locate the file that contains the route you want to activate or deactivate. (The eXplorist will automatically open the default file.)
5. With the file highlighted press **ENTER**.
6. Highlight the name of the route.
7. Press **ENTER**.
8. Highlight **Activate Route** or **Deactivate Route**.
9. Press **ENTER**.



Route List	
..al Memory\Routes\Routes File	
Up One Level	
1 TRAIL297	
2 MAGELLAN	
New route	
Legs	Distance
2	5%

List of routes with route named 'Magellan' active.

You will be returned to the last viewed navigation screen with the route chosen activated or deactivated.

Changing the Destination Leg of an Active Route

When a route is created it can have many different legs to the route, each leg with its own destination. If during your travels you wanted to skip some of the legs you can select the leg that you want to proceed to next.

An example would be your planned route starts at your campsite. The first leg goes to the bridge. The second leg goes across the bridge to the stone marker. Leg 3 leaves the stone marker and takes you to the ranger station. To finish out the route, the final leg goes from the ranger station to the swimming area. This route would be **Camp > Bridge > Marker > Ranger > Swim**. Suppose that after crossing the bridge you didn't want to go to the stone marker but instead go directly to the ranger station. Since the route is active (you can only select legs from active routes), you would follow the instructions below and tell the eXplorist to set the next leg to the ranger station. The route would be recomputed, eliminating the navigation instructions to go to the stone marker.

1. Press **MENU**.
2. Use the **Arrow** joystick to highlight **Routes**.
3. Press **ENTER**.
4. Locate the file that contains the active route. (The eXplorist will automatically open the default file.)
5. With the file highlighted press **ENTER**.
6. Highlight the name of the route. (Activated routes will be bolded in the list.)
7. Press **ENTER**.
8. Highlight **Select Leg**.
9. Press **ENTER**.
10. Use the **Arrow** joystick to highlight the next destination POI from the route list that you want to go to. In the example to the right, that would be Ranger.
11. Press **ENTER**.
12. Confirm that you want to do this by using the **Arrow** joystick to highlight **Yes**.
13. Press **ENTER**.
14. Press **NAV** to return to the last viewed navigation screen.



Route leg list with 'Ranger' selected. Note that 'Marker' is **bold** as it is the current active leg.

Editing a Saved Route

Saved routes can be edited to add a new leg at the end of the route (**<Add POI>**) remove a leg (**Delete POI**), insert a new leg (**Insert POI**) or change the destination from one POI to another (**Replace POI**).

1. Press **MENU**.
2. Use the **Arrow** joystick to highlight **Routes**.
3. Press **ENTER**.
4. Locate the file that contains the route you want to edit. (The eXplorist will automatically open the default file.)
5. With the file highlighted press **ENTER**.
6. Highlight the name of the route.
7. Press **ENTER**.
8. Highlight **Edit Route**.
9. Press **ENTER**.
10. *Adding a Leg:* Use the **Arrow** joystick to highlight **Add POI**. Press **ENTER**. Search the POI database for the new POI. The new POI will be added to the end of the route.
Inserting: Use the **Arrow** joystick to highlight the POI that you want to a new leg inserted in front of. Press **MENU**, highlight **Insert POI** and press **ENTER**. Search the POI database for the new POI. The new POI will be added inserting into the route you are creating.
Deleting: Use the **Arrow** joystick to highlight the POI you want to delete from the route. Press **MENU**, highlight **Delete POI**, and press **ENTER**.
Replacing: Use the **Arrow** joystick to highlight the POI you want to replace. Press **MENU**, highlight **Replace POI**, and press **ENTER**. Search the POI database for the new POI. The POI you select will replace the POI that was originally highlighted.
11. When the route has been edited, use the **Arrow** joystick to highlight **Save Route**.
12. Press **ENTER**.
13. *Optional:* Use the **Arrow** joystick and the **ENTER** button to input a name, up to ten characters, for the route.
14. Highlight **OK**.
15. Press **ENTER**.



Reversing a Route

Reversing a route takes a saved route and recreates it in reverse order. The sample route that was discussed earlier, **Camp > Bridge > Marker > Ranger > Swim**, would now be **Swim > Ranger > Marker > Bridge > Camp**.

1. Press **MENU**.
2. Use the **Arrow** joystick to highlight **Routes**.
3. Press **ENTER**.
4. Locate the file that contains the route you want to reverse. (The eXplorist will automatically open the default file.)
5. Press **ENTER**.
6. Use the **Arrow** joystick to highlight the name of the route you want to reverse.
7. Press **ENTER**.
8. Highlight **Reverse Route**.
9. Press **ENTER**.

Deleting a Route

The eXplorist can hold up to 20 different routes. When you have 20 routes saved you will need to delete one before you can create a new one.

1. Press **MENU**.
2. Use the **Arrow** joystick to highlight **Routes**.
3. Press **ENTER**.
4. Locate the file that contains the route you want to delete. (The eXplorist will automatically open the default file.)
5. With the file highlighted press **ENTER**.
6. Highlight the name of the route.
7. Press **ENTER**.
8. Highlight *Delete Route*.
9. Press **ENTER**.
10. Highlight *Yes* to confirm deletion, or *No* to cancel deletion.
11. Press **ENTER**.



Moving a Route

This provides you with a means of moving a route from one file to another.

1. Press **MENU**.
2. Use the **Arrow** joystick to highlight **Routes**.
3. Press **ENTER**.
4. Locate the file that contains the route you want to move. (The eXplorist will automatically open the default file.)
5. Press **ENTER**.
6. Highlight the name of the route.
7. Press **ENTER**.
8. Use the **Arrow** joystick to highlight **Move Route**.
9. Press **ENTER**.
10. Locate the file or create a new file for the route.
11. Press **ENTER**.
12. The route is moved and you are returned to the original route file.
13. Press **NAV** to exit.

Copying a Route

Copying a route makes an exact duplicate of a route that can then be edited, saving you time in creating a new route that is similar to an existing route. Another use would be to copy a route and reverse it.

1. Press **MENU**.
2. Use the **Arrow** joystick to highlight **Routes**.
3. Press **ENTER**.
4. Locate the file that contains the route you want to copy. (The eXplorist will automatically open the default file.)
5. Press **ENTER**.
6. Highlight the name of the route.
7. Press **ENTER**.
8. Use the **Arrow** joystick to highlight **Copy Route**.
9. Press **ENTER**.
10. Locate the file where you want to save the copied route. (You need to move it to a new route file, as saving it to the same file will overwrite the original without copying it.)
11. Press **ENTER**.

Viewing a Route on the Map

Viewing the route on the map gives you a way of graphically seeing the legs of the route as they appear on the map.

1. Press **MENU**.
2. Use the **Arrow** joystick to highlight **Routes**.
3. Press **ENTER**.
4. Locate the file that contains the route.
5. Press **ENTER**.
6. Highlight the name of the route.
7. Press **ENTER**.
8. Use the **Arrow** joystick to highlight **View on Map**.
9. Press **ENTER**.

The route is displayed with the map scaled to display the entire route. You can use the **Zoom In** and **Zoom Out** buttons to change the scale, and the **Arrow** joystick to move around the map.

10. When you are done viewing the route, press **ESC** to return to the *Route List* screen.

As you are moving, the eXplorist continuously records your track. Much like leaving breadcrumbs on the trail that you can use later to find your way back, the eXplorist leaves “electronic breadcrumbs” on the map. The advantage here is that you don’t have to worry about animals coming along and eating your return route markers.

This provides you with just another tool to make your eXplorist more valuable to you out in the field or on the waters. You can save your active track as a track log or as a multi-leg route that you can use over and over. You can also create a backtrack route that will guide you back to your starting point, following the same path you just took. You will find many other additional uses for track logs once you feel comfortable with them.

Track Logs

As mentioned above, track logs are records of your travels using electronic breadcrumbs to record where you have been. Track logs can be a track history that you have saved or the active track the eXplorist is recording.

Features of Track Logs:

- Active track is recording your travels whenever you are moving unless you have intentionally turned it off.
- Active tracks can be cleared, stopped, and resumed, adding flexibility to recorded tracking.
- Active tracks can be converted to a saved multi-leg route, providing a quick and easy way to create routes that can be used in the future.
- BackTrack, a function of Track Logs, provides an easy, and quick way to activate a route that will return you to your starting position.

Stopping and Resuming Active Track Logging

The instructions here describe the most common, and easiest way to create a GOTO route. Press **MENU**.

1. Use the **Arrow** joystick to highlight **Track Log**.
2. Press **ENTER**.
3. Highlight **Active Track**.
4. Press **ENTER**.
5. Highlight **Stop Logging** or **Resume Logging**.

Note: Stop Logging is displayed only when the active track is being recorded; Resume Logging appears only when the active track is not being recorded.

6. Press **ENTER**.

Note: The eXplorist will fill in a straight line from the point where track logging was stopped to the point where it has been resumed. This is true unless more than four hours have elapsed between the stop and the Resume Logging command. In that case, the eXplorist will not draw a straight line from the stop to the resume points of the track.



Track Log	
Internal Memory\Track Logs\	
Up One Level	
Active Track	
TKL6001	
Legs	Distance
--	0.00

Track Log List with information at the bottom

Starting a New Active Track Log

Before you can start a new active track log, you need to stop the one that is presently recording.

1. Press **MENU**.
2. Use the **Arrow** joystick to highlight **Track Log**.
3. Press **ENTER**.
4. Use the **Arrow** joystick to highlight **Active Track**.
5. Press **ENTER**.
6. Highlight **Stop Logging**. (If **Resume Logging** is displayed, the Track Log has already been stopped. Go to step 10.)
7. Press **ENTER**.
8. Use the **Arrow** joystick to highlight **Active Track**.
9. Press **ENTER**.
10. Highlight **New Track**.
11. Press **ENTER**.

Saving an Active Track Log

This will save your active track log with a name you enter that you can use at some time in the future. This does not erase your presently active route; only saves the current active track and adds it to the list of available track logs.

1. Press **MENU**.
2. Use the **Arrow** joystick to highlight **Track Log**.
3. Press **ENTER**.
4. Use the **Arrow** joystick to highlight **Active Track**.
5. Press **ENTER**.
6. Highlight **Save**.
7. Press **ENTER**.
If there are not enough track points to save, an alert will be displayed, informing you of the same and canceling the save.
8. Select the folder where you want the track log saved.
9. Press **ENTER**.
10. Use the **Arrow** joystick and **ENTER** button to assign a name for the track log.
11. Use the **Arrow** joystick to highlight **OK** when the name has been entered.
12. Press **ENTER**.

Creating a BackTrack Route

BackTrack routes use your active track to create a route back to where you started, turning around and following the electronic breadcrumb trail that the eXplorer dropped.

1. Press **MENU**.
2. Use the **Arrow** joystick to highlight **Track Log**.
3. Press **ENTER**.
4. Use the **Arrow** joystick to highlight **Active Track**.
5. Press **ENTER**.
6. Highlight **BackTrack**.
7. Press **ENTER**.
8. [Track logging is turned off alert status] Press **ENTER**.

After BackTrack has been activated, the last viewed navigation screen will be displayed. The eXplorer will now begin computing the navigation information needed to guide you back to your starting point.

NOTE: When you have an active BackTrack route, the eXplorer will not be recording track information. The previously mentioned options – Stop Logging, Resume Logging New Track – will not be available. The eXplorer will automatically begin recording your track when:

- You have arrived at your destination.
- You activate a new route (GOTO or from Route menu).
- You deactivate the BackTrack. To deactivate a BackTrack:

Press **MENU**

Highlight **Track Log**, press **ENTER**

Highlight **Active Track**, press **ENTER**

Highlight **Deactivate**, press **ENTER**

Press **ENTER**.

Clearing the Active Track

The active track can get to be very large, especially if you haven't cleared it in a while. It is recommended that if you plan to use BackTrack or to save the upcoming track log that you should clear the active track before beginning your journey. If you do not, the other functions will still work, but you will probably have a lot more track log information than you want.

1. Press **MENU**.
2. Use the **Arrow** joystick to highlight **Track Log**.
3. Press **ENTER**.
4. Use the **Arrow** joystick to highlight **Active Track**.
5. Press **ENTER**.
6. Highlight **Clear Track**.
7. Press **ENTER**.

The active track is cleared, and you are returned to the *Track Log* screen.

Converting the Track Log to a Route

This function takes the track log and turns it into a multi-leg route that is saved in your route list. From here, the route can be edited if necessary.

Note: Convert to Route is available for both active track logs and track logs you have saved.

1. Press **MENU**.
2. Use the **Arrow** joystick to highlight **Track Log**.
3. Press **ENTER**.
4. Use the **Arrow** joystick to highlight Active Track or any track log you have previously saved.
5. Press **ENTER**.
6. Highlight **Convert to Route**.
7. Press **ENTER**.
8. Use the **Arrow** joystick and **ENTER** button to assign a name for the route. Route names can be up to ten characters in length.
9. Use the **Arrow** joystick to highlight **OK** when the name has been entered.
10. Press **ENTER**.
11. Use the **Arrow** joystick to select the file where you want the route saved.
12. Press **ENTER**.

Viewing the Track Log on the Map

Selecting View on Map displays the track log chosen and plots it on the Map screen. This gives you the opportunity to graphically view the track log.

Note: View on Map is available for both active track logs and track logs you have saved.

1. Press **MENU**.
2. Use the **Arrow** joystick to highlight **Track Log**.
3. Press **ENTER**.
4. Use the **Arrow** joystick to highlight **Active Track** or any track log you have previously saved.
5. Press **ENTER**.
6. Highlight **View on Map**.
7. Press **ENTER**.

The *Map* screen is displayed, in the Cursor mode, with the selected track log displayed on the screen. The **ZOOM IN** and **ZOOM OUT** buttons can be used to change the map scale, and the cursor can be moved by using the **Arrow** joystick.

When you have finished viewing the track, press **ESC** to return to the *Track Log* screen.

Working with Saved Track Logs

It has been mentioned before that you can convert saved track logs to a route and view saved track logs on the map. There are three functions unique to saved track logs that you can perform: following, reversing, and deleting the track.

Following Saved Track Logs

This function provides you with a means to use a saved track as a multi-leg route. Once this function has been activated, the eXplorer will navigate you along your saved track.

1. Press **MENU**.
2. Use the **Arrow** joystick to highlight **Track Log**.
3. Press **ENTER**.
4. Use the **Arrow** joystick to highlight any track log you have previously saved.
5. Press **ENTER**.
6. Highlight **Follow Track**.
7. Press **ENTER**.
8. [Track logging will be turned off alert status.] Press **ENTER**.

The last viewed navigation screen is displayed with the track log selected being used as an active route.

Reversing a Saved Track Log

Reversing a saved track log is identical to following a saved track log, with the exception that the route created is reversed from the original track log.

1. Press **MENU**.
2. Use the **Arrow** joystick to highlight **Track Log**.
3. Press **ENTER**.
4. Use the **Arrow** joystick to highlight any track log you have previously saved.
5. Press **ENTER**.
6. Highlight **Reverse Track**.
7. Press **ENTER**.
8. [Track logging will be turned off alert.] Press **ENTER**.

The last viewed navigation screen is displayed with the reversed track log selected being used as an active route.

Deleting a Saved Track Log

Use this function to remove track logs that have been previously saved and are no longer needed.

1. Press **MENU**.
2. Use the **Arrow** joystick to highlight **Track Log**.
3. Press **ENTER**.
4. Use the **Arrow** joystick to highlight any track log you have previously saved.
5. Press **ENTER**.
6. Highlight **Delete Track**.
7. Press **ENTER**.

The saved track log is deleted, and you are returned to the Track Log screen.

Moving a Saved Track Log

Use this function to move a track log that has been saved to a new location.

1. Press **MENU**.
2. Use the **Arrow** joystick to highlight **Track Log**.
3. Press **ENTER**.
4. Use the **Arrow** joystick to highlight any track log you have previously saved.
5. Press **ENTER**.
6. Highlight **Move Track**.
7. Press **ENTER**.
8. Locate the location where you want the track log stored.
9. Highlight **Move to here**.
10. Press **ENTER**.

Copying a Saved Track Log

Use this function to copy a track log that has been saved.

1. Press **MENU**.
2. Use the **Arrow** joystick to highlight **Track Log**.
3. Press **ENTER**.
4. Use the **Arrow** joystick to highlight any track log you have previously saved.
5. Press **ENTER**.
6. Highlight **Copy Track**.
7. Press **ENTER**.
8. Locate the location where you want the track log stored.
9. Highlight **Copy to here**.
10. Press **ENTER**.
11. Use the keyboard to enter a new name for the track log.
12. When the name is correct, highlight **OK** and press **ENTER**.

The eXplorist has a set of advanced features that provides you with additional features to enhance the use of your eXplorist. The advanced features are accessed from the Main Menu and include:

- **Area Calculation:** This will compute the area and the perimeter of a region that you define.
- **Fish/Hunt:** This will display the best hunting and fishing times for a position and date that you enter.
- **Sun/Moon:** This will display the rising and setting times for the sun and the moon for any position and date you enter. It also displays the phase of the moon for that position and date.
- **Vertical Profile:** This will graph the elevation levels for your active or a saved track log. (If you have a MapSend Topo detailed map, it can also display a vertical profile of routes you have saved.)
- **Simulate:** Provides you a tool for putting the eXplorist into a simulate mode. With the simulator turned on, the eXplorist will operate as if it was moving. This provides a tool for you to use to try different functions while sitting at your desk or campsite.
- **Communications:** This is used to set your eXplorist into the mode you desire when it is connected to a personal computer through the USB port. You can set up file transfers, transferring NMEA data, or just using the USB cable to power the eXplorist.

Using Area Calculation

Area Calculation uses three or more POIs that you select to create and display a region on a miniature map display. It then takes this region and computes its area and perimeter.

Calculating an Area

1. Press **MENU**.
2. Use the **Arrow** joystick to highlight **Adv. Features**.
3. Press **ENTER**.
4. Highlight **Area Calculation**.
5. Press **ENTER**.
6. Highlight **<Add Point>**.
7. Press **ENTER**.

Note: Any previous area calculations you did are saved in memory and will be displayed. To create a new area calculation you will first need to delete all of the POIs from the list. How to delete all of the POIs will be explained following these instructions.

8. Using the POI database, select a stored POI.
9. Repeat steps 6 through 8 until you have a region defined.
10. The bottom of the display will alternate between the area and the perimeter of the region you have defined.

Deleting All POIs from the Area Calculation List

1. While viewing the *Area Calculation* screen, press **MENU**.
2. Highlight **Delete All Points**.
3. Press **ENTER**.
4. All of the POIs in the list are removed and you can now create a new region to be calculated.

Editing the POI List in Area Calculation

You can insert, delete, or replace a POI in the area calculation list.

1. Use the **Arrow** joystick to highlight the POI in the list that you want a new POI added before, deleted, or replaced.
2. Press **MENU**.
3. Use the **Arrow** joystick to highlight **Insert Above**, **Delete**, or **Replace**.
4. Press **ENTER**.
5. If you select **Insert Above** or **Replace**, you will select a POI from the POI database.

Computing Best Fish/Hunt Times

This provides you with the means to view the good and excellent fishing and hunting times for any POI and date you select.

Accessing Hunting and Fishing Times

1. Press **MENU**.
2. Use the **Arrow** joystick to highlight **Adv. Features**.
3. Press **MENU**.
4. Use the **Arrow** joystick to highlight **Fish/Hunt**.
5. Press **ENTER**.
6. The *Fish/Hunt* screen is displayed with the position and date set to your present position and today's date.

Fish/Hunt	
At	Position
On	13 JUL 05
Excellent:	
From	To
05:15AM	07:15AM
05:35PM	07:35PM
Good:	
From	To
11:36AM	01:36PM
11:56PM	01:56AM

Changing the Position

1. With the Fish/Hunt screen displayed, highlight the **At** field.
2. Press **ENTER**.
3. Select a POI from the POI database.

Changing the Date

1. With the *Fish/Hunt* screen displayed, highlight the **On** field.
2. Press **ENTER**.
3. Use the **Arrow** joystick to change the date.
Up/Down changes the data at the cursor position; Left/Right moves the cursor.
4. When the date is correct, press **ENTER**.

Displaying Sun and Moon Information

Using the Sun/Moon feature you are able to view the sunrise, sunset, moonrise and moon setting times, as well as viewing the phase of the moon, for any POI in your database.

Accessing the Sun/Moon Function

1. Press **MENU**.
2. Use the **Arrow** joystick to highlight **Adv. Features**.
3. Press **MENU**.
4. Use the **Arrow** joystick to highlight **Sun/Moon**.
5. Press **ENTER**.
6. The *Sun/Moon* screen is displayed with the position and date set to your present position and today's date.

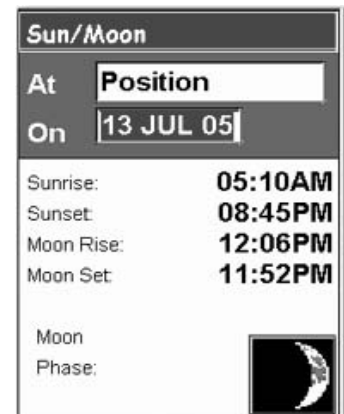

Changing the Position

1. With the *Sun/Moon* screen displayed, highlight the **At** field.
2. Press **ENTER**.
3. Select a POI from the POI database.
4. Press **ENTER**.

Changing the Date

1. With the *Sun/Moon* screen displayed, highlight the **On** field.
2. Press **ENTER**.
3. Use the **Arrow** joystick to change the date.
Up/Down changes the data at the cursor position; Left/Right moves the cursor.
4. When the date is correct, press **ENTER**.

Viewing the Vertical Profile

Vertical Profile will graphically display the elevation for a track log that you select. This can be your active track log or one you have saved. If you have loaded a detail map from one of the MapSend Topographic software packages, you can also view the vertical profile for routes you have created.

1. Press **MENU**.
2. Use the **Arrow** joystick to highlight **Adv. Features**.
3. Press **ENTER**.
4. Use the **Arrow** joystick to highlight **Vertical Profile**.
5. Press **ENTER**.
6. Highlight **Track History**. (When a MapSend Topographic detailed map has been loaded, you can select one of the other available options.)
7. Press **ENTER**.
8. Highlight **Active Track** or saved track that you want to view.
9. Press **ENTER**.

The vertical profile for the selected item is displayed. You can use the **Arrow** joystick to move the displayed profile left or right. As you move the profile, the center mark will display the elevation for the point indicated.

Using the Simulator

When the eXplorist is placed in the simulator mode, it simulates movement along a predefined or saved route.

1. Press **MENU**.
2. Use the **Arrow** joystick to highlight **Adv. Features**.
3. Press **ENTER**.
4. Use the **Arrow** joystick to highlight **Simulate**.
5. Press **ENTER**.
6. Highlight the desired option:

Off - Turns the simulator off

Auto - Uses a predefined route. (This is a 3-leg route in the shape of a triangle with your present position as the starting point.)

User - Uses the same predefined route as Auto, but provides a way to change the heading and speed. The simulator will follow the heading and speed, even when if this means it doesn't follow the predefined route.

7. If you have an active track log being recorded, the simulator will need to delete this track. A warning is displayed that your track will be deleted. Highlight **Yes** and press **ENTER** to erase the track and continue.
8. An alert is displayed indicating that the simulator has been turned on. Press **ENTER**.
9. Press **NAV** to return to the last viewed **Map** screen.



Simulating on a Saved Route

1. Follow the instructions above to turn the simulator on.
2. After you have returned to the last viewed *Map* screen, press **MENU**.
3. Highlight **Routes**.
4. Press **ENTER**.
5. Highlight a saved route to use. (Note: You will notice a new route whose name is bolded indicating that it is the active route. This is the predefined route that the simulator has created. Do not select this route if you are wanting to view a route you have created.)
6. Press **ENTER**.
7. Highlight **Activate Route**.
8. Press **ENTER**.

Communicating with a Personal Computer

For this feature to operate properly, you must have your eXplorist connected to a personal computer through the computer USB port

Connecting to a Personal Computer

1. Turn the eXplorist off.
2. First connect the PC interface cable to the connector on the back of the eXplorist.
3. Insert the USB connector on the PC interface cable to any of the USB ports on a personal computer.
4. Turn the eXplorist on.
5. You may get a message on your computer that a new USB device has been found.
6. If connected properly, the eXplorist will display the USB File Transfer screen, indicating that the eXplorist is in the file transfer mode.

Changing Modes

When you are connected to a personal computer you have three modes that the eXplorist can be in. File Transfer mode allows you to transfer files to and from the eXplorist and the personal computer. NMEA Data Comm mode outputs the GPS data from the eXplorist in NMEA format for use with external software. Power Only mode turns off data communication with the personal computer and the eXplorist operates normally.

1. If the eXplorist has just been turned on, the *USB File Transfer* screen is already displayed. Skip steps 2 through 6.
2. Press **MENU**.
3. Use the **Arrow** joystick to highlight **Adv. Features**.
4. Press **ENTER**.
5. Highlight **Communications**.
6. Press **ENTER**.
7. Highlight **File Transfer**, **NMEA Data Comm**, or **Power Only**.
8. Press **ENTER**.

Working with Files on the Personal Computer

You can work with the files saved in your eXplorist or files located on an SD card in the eXplorist (optional). Using the personal computer, you have complete access to moving, renaming, modifying, or deleting any of the saved files. Special care should be taken whenever working with saved files as unwanted results may occur. It is advised that you backup any files that you plan on editing in case something unexpected happens. When you first turn the eXplorist on while connected with the USB cable it is automatically in the File Transfer mode using the internal memory of the eXplorist. To work with files on the SD card you need to tell the eXplorist that you want to work from there.

1. Follow the previous instructions to connect the eXplorist to your personal computer.
2. If the USB File Transfer screen is not being displayed, follow the above instructions to select the File Transfer mode.
3. To change from internal memory to the SD card: Press **ENTER**. Highlight FileTransfer and press **ENTER**. Highlight **Internal Memory** or **SD Card** and press **ENTER**. (You may get a notification that a USB device was disconnected. This is normal and just click the OK button.)
4. Left-click the “My Computer” icon found on the desktop. From the drop-down menu, select Explore.
5. Find the new drive in the left-hand list of folders. It will be called “Removable Disk (X:)” with “X:” being the assigned drive letter.
6. Using normal window commands, you can copy, rename, move, and delete any of the files.
7. You can also view and modify the files using any text editor. If you modify the files, you need to save them as text only files. The following is a sample of a POI file being modified using WordPad.

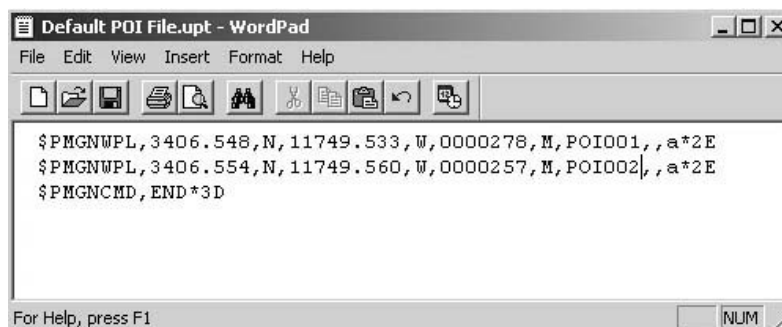

Magellan Geocache Manager

What is Geocaching?

Very simply, geocaching is a fun, recreational game that you can play using your eXplorist receiver. It's been referred to as "electronic treasure hunting" and is just that. Caches are hidden all over the world and your task is to find them, armed only with the coordinates of the cache and your Magellan eXplorist.

People will hide caches, usually in a waterproof container (the military ammo box is very popular), and record the latitude/longitude coordinates for the cache. Inside the container is the "bounty" that is the prize for locating the cache. In many cases there may be a log book for you to sign, indicating that you have found the cache. You can take your prize from the cache and, as many do, leave something new in the container for the next person who comes along.

The popularity of geocaching is growing rapidly everyday and new geocache points are constantly being added. For more information on geocaching, as well as a great source of geocache points, visit GEOCACHING at www.geocaching.com.

What is the Magellan Geocache Manager?

The Magellan Geocache Manager is a software application that runs in Windows® on your personal computer. It is a place to create, modify, store, and most importantly, upload geocache points to your eXplorist.

There are two ways of adding geocache points to the Magellan Geocache Manager. You can enter the points manually by typing in the information or you can download geocache points from one of the many geocache fansites found on the Web. The Magellan Geocache Manager has a link to www.geocaching.com under the Help menu which is a great source for finding and downloading geocache points.

How Do I Install the Magellan Geocache Manager?

Insert the Magellan Wizard CD-ROM that came with your eXplorist into the CD-ROM drive on your personal computer. It will automatically load and the Main Menu will be displayed.

Click on "Install software" and follow the instructions to install the Magellan Geocache Manager.

Once the software is installed, you can Exit from the eXplorist Wizard and the Magellan Geocache Manager is ready to use.





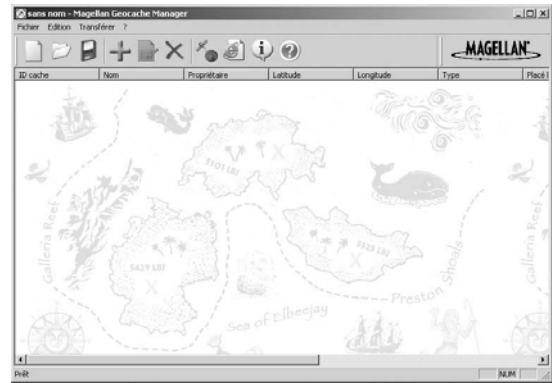



Using the Magellan Geocache Manager

1. Access the Magellan Geocache Manager by using the Start button on the Windows toolbar.
2. Under “Programs” select ‘Magellan > eXplorist XL > Magellan Geocache Manager’.
3. The Magellan Geocache Manager will open and an empty list of geocache points is displayed.
4. The common tools are displayed as icons at the top of the display. You can access the function by clicking on the icon, selecting from the menu, or using one of the hotkey shortcuts.



Magellan Geocache Manager Tools

Using the icons at the top of the window is the easiest way of accessing the most common functions. The following lists the icons, their hotkey equivalent, and their usage.

Icon	Name	Hotkey	Description
	New	Ctrl+N	Creates a new database for saving geocache points. This closes the active database, with the option of saving if you have made any changes.
	Open	Ctrl+O	Opens previously saved geocaching databases. Also allows you to append previously saved geocache files to the existing file.
	Save	Ctrl+S	Saves the opened database with any changes that have been made. (Use 'Save As' under the File menu if you want to save the opened database under a new name.)
	Add	Insert	Adds a new geocaching point to the list. Geocaching points added to the list using the Add icon require that you input the information for the point.
	Modify	Enter	Opens a window for geocache point that you have highlighted. In this window you can edit the information for that point.
	Delete	Delete	Deletes the highlighted geocache point from the list.
	Upload	Shift+5	Uploads the selected or the entire list of geocache points to the eXplorer. This requires that the eXplorer is connected to the USB port of the computer and is in the USB File Transfer mode
	About	Alt+A	Opens the 'About...' window with information about the version of the Magellan Geocache Manager software that you are using.
	Help	F1	Opens a help file with information to assist you in using the Magellan Geocache Manager software.

Working with Geocache Files

This is a picture of a sample geocache file with a list of geocache points. You can modify this list by editing, deleting, or adding points to it.

You can also add other downloaded geocache point files to this list but you will need to follow the instructions provided below.

Finally, instructions will be shown as to how to select files and upload them to your eXplorist.

ID cache	Nom	Propriétaire	Latitude	Longitude	Type	Placé
GCKCG4	Permission	embryonarror	34° 6.349N	117°48.836W	Geocache	
GCK2Q6	Welcome Wagon	Terra Girl	34° 6.390N	117°49.177W	Geocache	
GCK2Q9	What's a Henge?	Terra Girl	34° 6.409N	117°49.075W	Geocache	
GCK8Y1	The Casey Mears C...	embryonarror	34° 6.266N	117°49.386W	Geocache	
GCKJ15	Tilting at Windmills	rockitz	34° 5.749N	117°49.212W	Geocache	
GCK1RM	Lazy Bones	Terra Girl	34° 6.380N	117°49.364W	Geocache	
GCK9A8	Raging View	Geo Jeff	34° 5.684N	117°48.842W	Geocache	
GCK7X1	The Jimmy Johnson ...	embryonarror	34° 6.523N	117°49.210W	Geocache	
GCK2QG	Tickets Please	Terra Girl	34° 6.378N	117°48.577W	Geocache	
GCK7WZ	Magellan's Landing	OCBTraker	34° 6.504N	117°49.430W	Geocache	
GCH7W	Grille Foo Foo	Hawkeye_Mary & S...	34° 5.540N	117°49.028W	Geocache	
GCK2RA	Flavor House	Terra Girl	34° 6.325N	117°48.419W	Geocache	
GCKRK4	Choppers	Terra Girl	34° 5.976N	117°49.747W	Geocache	
GCHN98	Bonell	xpods	34° 5.530N	117°48.742W	Geocache	
GCK2QH	The Mansion	Terra Girl	34° 6.457N	117°48.448W	Geocache	
GCK2GB	Black Holey Rock	OCBTraker	34° 5.519N	117°49.483W	Geocache	
GCHNN3	D. Ant Trail #1	S.O.S.Mike	34° 5.427N	117°49.307W	Geocache	
GCK2Q4	Jack in the Cache	Terra Girl	34° 6.452N	117°49.795W	Geocache	
GCHTRN	Tanked Up	Terra Girl	34° 6.797N	117°48.910W	Geocache	
GCK2G6	Sign of the Pug	OCBTraker	34° 5.514N	117°49.610W	Geocache	
GCKMW1	3D Cachers' Winter ...	pacachers	33° 1.029N	117° 4.484W	Geocache	
GCKMW1	3D Cachers' Winter ...	pacachers	33° 1.029N	117° 4.484W	Geocache	

Adding Other Downloaded Files to the List

It is possible to add downloaded files to this list. To do this you need to follow these instructions:

1. Click the Open Icon.
2. Using the Windows Open File window, select the downloaded file you want to add.
3. At the bottom of the window is a radio button 'Append to existing list'. Make sure that this button is marked.
4. You may get an alert asking you to 'Save changes to <filename>?'
Yes - Appends the geocache list and opens up a window asking you to rename the file and indicate where you want the new file saved.
No - Appends the geocache list to the file that is open without requiring you to do a 'Save As...'.
Cancel - Cancels the action and no points are appended to the list.
5. Click the appropriate button.

Uploading to the Magellan eXplorist

1. Turn the eXplorist off and connect it to the USB port on your computer.
2. Turn the eXplorist on. If connected correctly, it will begin in the USB File Transfer mode or the Communications menu is displayed. (If the Communications menu is shown, select **USB File Transfer** and press **ENTER**.) If neither of these screens is displayed there maybe a bad connection. Turn the eXplorist off and check the connections and try again. The eXplorist must be in the USB File Transfer mode for geocache points to be uploaded.
Note: By default the eXplorist will save to its internal memory. If you want to save to the SD card instead, from the USB File Transfer screen yo need to:

Press **ENTER**

Highlight **USB File Transfer** and press **ENTER**.

Highlight **SD Card** and press **ENTER**.

3. Select the files to be uploaded. (If no files are selected, it is assumed that you want to upload the entire list.)

Tips on selecting files:

To select a single geocache point, click on the name.

To select multiple, consecutive geocache points, hold the Shift key down while clicking on the geocache point names.

To select multiple, non-consecutive geocache points, hold the Ctrl key down while clicking on the geocache point names.

4. Click the Upload Icon on the Magellan Geocache Manager.
5. Make sure that the correct radio button is selected (All Geocaches or Selection).
6. Click on the OK button.
7. Select the location for the file to be saved.
(By default this is the 'Geocaches' folder in the internal memory or on the SD card.)
8. If the transfer is successful, an alert will be displayed.
9. You are now able to access and create a GOTO to any of the geocache points following the instructions for creating a GOTO. (Geocache points can also be used in multi-leg routes but the most common usage will be in a GOTO.)

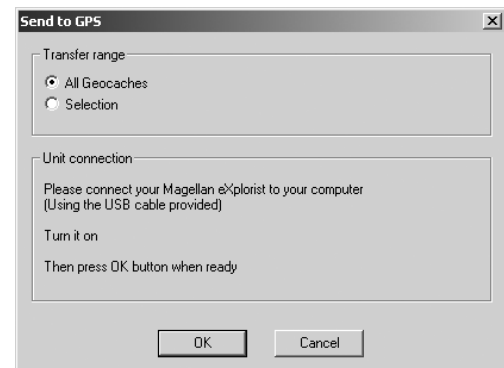

Using the eXplorist with MapSend

What is MapSend?

MapSend® is the Magellan line of detailed digital maps for Magellan hand-held GPS receivers. The core MapSend product line includes street maps for driving, topographic maps for hiking, camping, and hunting, and fresh/salt water maps for fishing and boating. MapSend maps will transform your eXplorist into an amazingly powerful solution for outdoor recreation and travel.

You can find out more about the growing line of MapSend products through a Magellan dealer or on-line www.magellangps.com under Products > Maps and Software.

Most MapSend products are provided on CD-ROM for use on personal computers using the Windows® operating system.

- MapSend maps typically cover large areas, allowing the user to ‘cut’ smaller regions to be uploaded and saved as one of the detailed maps available for your eXplorist.
- Other useful trip planning and map analysis functions, such as the ability to easily create and store POIs, routes, map regions, etc.
- Plug and play in the eXplorist, but are limited in geographic area.

Please note that not all MapSend products will presently work with the eXplorist. Please check the Magellan web site at www.magellangps.com and go to the eXplorist web for a link to details on compatibility with your eXplorist and MapSend software.

The following instructions are basic guidelines for using MapSend with your eXplorist. Please refer to the documentation provided with your MapSend product for more detailed information and product updates.

Overview of Uploading Detail Maps from MapSend to the eXplorist

Install MapSend Software. Following the instructions provided with the MapSend product you purchased, the first step is to install the software onto your personal computer. For this overview, the MapSend Topo 3D will be used.

Open MapSend and Define a Region. Zoom in and pan until you find an area that you are interested in. Using the Draw New Region tool, define the region.

Right-click inside the region. This will bring up a window for you to enter a name for the region. In this example it is called “Tahoe.”

Notice that in the lower right corner the size of the region is displayed.

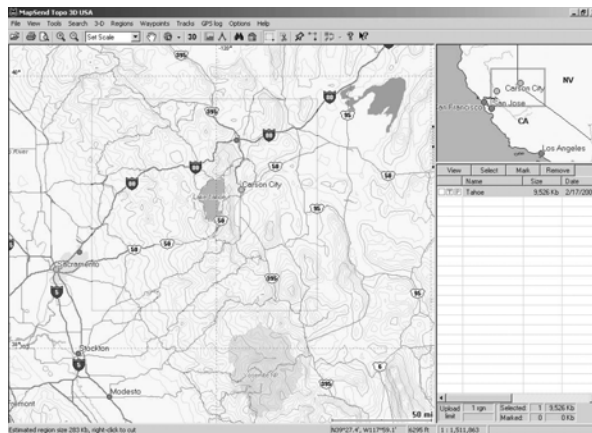

Notice that in the lower right corner the size of the region is displayed. You may choose to put large regions on an SD card to save internal memory.

Saving Map Regions. Before saving the region, review the documentation that came with MapSend to set what information will be saved with the region. In this example, Topo information and POIs are wanted, so in the region list make sure that the “T” and “P” boxes to the left of the region name are bolded. Next, mark the region for saving by clicking the checkbox to the left of the region name.

	Name	Size	Date
<input checked="" type="checkbox"/> T P	Tahoe	9,607 Kb	2/17/2005

Save the Region to Your Computer's Hard Drive. Under the Regions menu, select “Upload to GPS...” (Ctrl+U). Click on the radio button for “Save on Hard Drive.”

IMPORTANT: Do NOT save directly to an SD card or directly to the GPS unit. Map files saved from MapSend need to be converted before using them in the eXplorist. Maps saved directly to an SD card from MapSend will not work in the eXplorist.

Click the Next > button.

Enter the serial number for your eXplorist in the space provided. This can be found on your eXplorist by accessing the *About...* screen (accessed from the main menu). Do not use any of the Settings or Connect buttons. Once the serial number has been entered, click **Next** >. You will be asked to confirm the serial number.



The Ready to Update window is displayed with information about the region that you are saving. Click on the **Finish** button to begin saving the region.

Note: MapSend automatically saves files to a specified location. The path to the saved files is: Local Disk C:\Program Files\Magellan\MapSend Product Name\Export\Images.

Connect the eXplorist to the Personal Computer: (This applies only if you are uploading the detail map to the eXplorist or to an SD card installed in the eXplorist.)

Turn off the eXplorist and connect the USB cable supplied with your eXplorist to the back of the eXplorist and a USB port on your computer. Turn the eXplorist on. The eXplorist will come up in the USB File Transfer mode. (If not, and the Communication screen is displayed, press **ENTER**. Select USB File Transfer and press **ENTER**. Select Internal Memory or SD Card and press **ENTER**.)

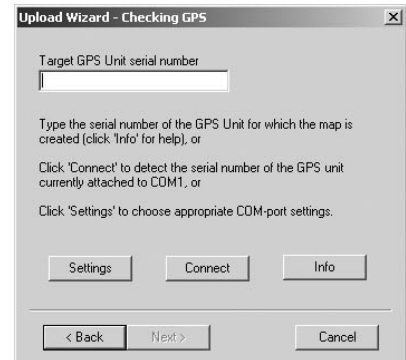

Memory space in the eXplorist is very limited and it is recommended that you save detailed maps to an SD Card. In this example, the eXplorist has been turned on and is in the USB File Transfer mode, but internal memory is selected. To change to the SD card, press **ENTER**. Select USB File Transfer and press **ENTER**. Select SD Card and press **ENTER**.)

Transfer the Files using the Magellan Conversion Manager: Launch the Magellan Conversion Manager (installed from the Magellan Wizard). It can be found under the 'Start' menu - Start > Programs > Magellan > eXplorist XL > Magellan Conversion Manager.

When first opened, on the Welcome window select 'Transfer Map Regions' and click **Next**.

A reminder to connect the Magellan eXplorist to the computer is presented. Click **Next**.

The Magellan Conversion Manager will automatically search for detail maps (*.imi) or background maps (*.mgi) on your computer available for uploading.

The Map region selection window is displayed. In this window you will select which map regions that will be uploaded.

If you do not see a map that you believe you have saved, you can browse for it by clicking on the Magnifying glass icon.

(In this example we are uploading a detailed map, background maps are uploaded following these same guidelines.)

The popup menu to the right shows where the files will be saved. If you have an external SD card reader/writer, you can select it there.

Please remember that large map regions should be saved to an SD card. (Please make sure that there is room on the SD card for the map you want to upload.) The internal memory of the eXplorist is limited and large detail maps with either not fit or will take up memory that you will need later for saving POIs and creating routes.

Select the map regions you want to upload by clicking the checkbox next to the map region name in the list of map regions. When at least one map is selected, the Next button is made active. When you have all the map regions you want upload selected, click Next.

The map regions will be transferring and two progress bars will indicate the progress. When the transfer is completed you will see a 'Transfer completed' message and the Next button will be active. Click Next. The final window just verifies that the transfer has been completed. Click Finish.

The map region has now been uploaded to either the Magellan eXplorist, the SD card mounted in the eXplorist, or to an SD card in a card reader/writer. If you had chosen an external SD card reader/writer, remove the card and install it in your eXplorist.

Select Map: Now that the detailed or background map has been successfully uploaded, select the map for use. Press Menu. Highlight Preferences and press **ENTER**. Highlight Active Setup and press **ENTER**. Highlight Detail Maps or Background Maps field and press **ENTER**. Select map and press **ENTER**. (Note: for a detail map, you need to select Select Map from the popup menu and press **ENTER**.)



Transferring POIs, Routes, and Track Between MapSend and eXplorist

You can transfer POIs, routes and track logs to and from MapSend and the eXplorist using the Magellan Conversion Manager. Since the eXplorist stores these data items in a more accessible manner than previous GPS receivers, you must use the Magellan Conversion Manager instead of transferring the files directly in MapSend. (The Magellan Conversion Manager can be installed using the Magellan Wizard CD-ROM that came with your eXplorist.)

Transferring POIs, Routes, and Tracks to MapSend

1. Access the Magellan Conversion Manager by using the Start button on the Windows toolbar.
2. Under "Programs" select 'Magellan > eXplorist XL > Magellan Conversion Manager'.
3. Click the radio button for 'Convert Waypoints / Routes / Tracks' and click Next >.
4. Turn off the eXplorist and connect the USB cable to the eXplorist and the personal computer's USB port.
5. Turn the eXplorist on. (By default, files are uploaded to the internal memory, to select the SD card: Press **ENTER**. Highlight File Transfer and press **ENTER**. Select SD card and press **ENTER**.)
6. Click the Next > button on the Magellan Conversion Manager.
7. Select 'Convert to MapSend' (sending data points from the eXplorist to MapSend). Click Next >.
8. Click on the active folder icon. In the example shown, files are being transferred from the eXplorist to MapSend.
9. Browse through the folders and select the POI, route or track log files to be transferred.
10. Click Next >.
11. A progress bar is displayed and will indicate when the transfer has completed.
12. Click Next > and finally click Finish to conclude the transfer.
13. Open the MapSend software program and under the Waypoints or Track menu, select 'Load from File...'. Select the file that you converted.

Transferring Waypoints, Routes, and Tracks from MapSend

The process for transferring from from MapSend to the eXplorist is similar to the one described above.

1. Open the MapSend software program. This procedure will discuss sending waypoints to the eXplorist. Use similar steps for transferring routes and tracks.
2. Click the Place Waypoint icon at the top of the MapSend display to bring up the Waypoint List.
3. All waypoints in the list will be transferred, including those not checked.
4. From the Waypoint Menu, select 'Save to File...'. Enter a name for the file and click Save.
5. Access the Magellan Conversion Manager by using the Start button on the Windows toolbar. Under "Programs" select 'Magellan > eXplorist XL > Magellan Conversion Manager'.
6. Click the radio button for 'Convert Waypoints / Routes / Tracks' and click Next >.
7. Turn off the eXplorist and connect the USB cable to the eXplorist and the personal computer's USB port.
8. Turn the eXplorist on. Press **ENTER**. From the *Communications* screen, highlight **File Transfer** and press **ENTER**. Select **Internal Memory** or **SD card** and press **ENTER**.
9. Click the Next > button on the Magellan Conversion Manager.
10. Select 'Convert to eXplorist' (sending data points from MapSend to the eXplorist) Click Next >.
11. Click on the active folder icon. In the example shown, files are being transferred from MapSend to the eXplorist.
12. Browse through the folders to find the waypoint files to be transferred.
13. Click Next >.
14. A progress bar is displayed and will indicate when the transfer has completed.
15. Click Next > and finally click Finish to conclude the transfer.
16. The next time you access POI List, you will be able to select the file that was just uploaded.

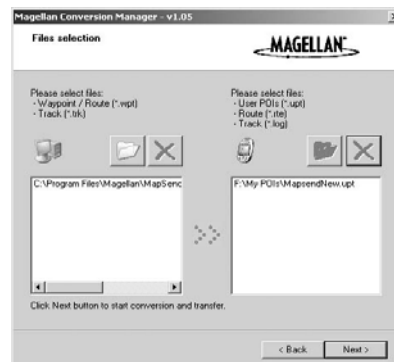

The Preferences portion of the eXplorist provides the tools to personalize the eXplorist to your usage and needs. There are tools that are designed to give you full flexibility over its use as well as performing maintenance on the internal memory should the need arise.

Features found in Preferences:

- Restarting the GPS (Initializing) to give the eXplorist its approximate location if it has been moved a large distance while turned off.
- A way of setting default folders for saving POI's, routes, etc.
- Access to setting the units of measure for information displayed.
- A means to set the north reference used to be either magnetic north or True North.
- The coordinate system for position information and the map datum used to compute the coordinate information can be chosen.
- Full control over the built-in power-management tools to assist in prolonging battery life.
- Personalize your eXplorist.
- Choose from ten different languages that can be used to display information.
- Access to tools that will provide you with the means to clear all or part of the internal memory.
- Ability to set alarms to alert you when you have lost GPS signal, when you are getting near your destination, and other useful alerts.
- A way of resetting the clock and customizing your daylight savings requirements.

Restarting the GPS

Restarting the GPS provides a means of giving the eXplorist information about its approximate position, long time GPS receiver users will know this option as initializing. To understand when you would use this option, a brief explanation of how the eXplorist works will be helpful.

The GPS constellation consists of 24 satellites and three spares that orbit the earth, and at any given time of the day a different collection of satellites will be overhead. To keep track of what satellites are in view, the eXplorist has a built-in almanac that uses the present date and time, along with its approximate position, to "look-up" what satellites should be in view. Every time you turn your eXplorist off, it records in a special place in its memory, the last position fix computed, and then when it is turned back on, it assumes that it is still in the same approximate location and uses this last position fix when doing its "look-up" in the almanac.

Now if you turn your eXplorist off and fly across the country, the next time you turn it back on, it will think it is still at the location where it was turned off, and begin looking for the satellites it thinks are overhead. If the satellites are not there, the eXplorist begins "polling" the skies, trying to determine what satellites are in view. This process can take time and can appear as if the GPS portion of the eXplorist is not working. Under normal conditions, the eXplorist will still be able to compute your position but this can take longer than normal.

What **Restart GPS** does is it gives you the ability to give the eXplorist its approximate location, hence speeding up the time to acquire its first fix. Many eXplorist users will never need to use the Restart the GPS option, but it is available should the need arise.

When to use **Restart GPS**:

- When the eXplorist has been moved more than 500 miles (804.67 km) while turned off.
- When the eXplorist is sluggish and takes more than a few minutes to compute its first position fix when turned on. (This really isn't an option that you need to be concerned about. The eXplorist has a built-in feature that when it has trouble computing its first position fix, it automatically asks you to supply the approximate position.)

Restarting the GPS:

1. Press **MENU**.
2. Use the **Arrow** joystick to highlight **Preferences**.
3. Press **ENTER**.
4. Use the **Arrow** joystick to highlight **Restart GPS**.
5. Press **ENTER**.

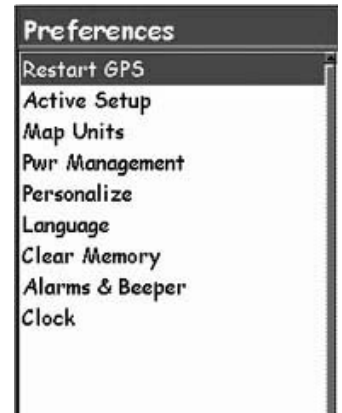

6. *Region.* Use the **Arrow** joystick to highlight the region of the world for your present location.

You can also enter the coordinates for your present position if you know them by highlighting **Enter Coord**. This is rarely used and is not described in this manual.



7. Press **ENTER**.

8. *Area.* Use the **Arrow** joystick to highlight the area of your location. The list of areas is different for each region selected in step 6.

9. Press **ENTER**.

10. *Time.* Use the **Arrow** joystick to enter the current time. Push the **Arrow** joystick up or down to change the value and left or right to move the cursor.



Note: Time is one of the first pieces of information transmitted by the satellites and even without enough satellite information to compute a position fix, the time displayed may have already been corrected.

11. Press **ENTER**.

12. *Date.* Use the **Arrow** joystick to enter the present date. Push the **Arrow** joystick up or down to change the value and left or right to move the cursor.

Note: Date is also sent by the satellites and may already be correct as well.

13. Press **ENTER**.
14. Use the **Arrow** joystick to highlight **Done**.
15. Press **ENTER**.
16. The last viewed navigation screen is displayed and the eXplorist will begin tracking satellites.

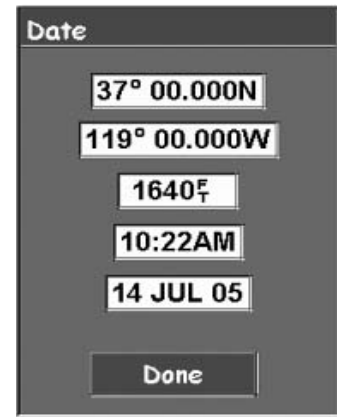

Using Active Setup

Whenever you need to access POIs, routes, and other saved data, the eXplorist automatically goes to the default file for the particular piece of data you are working with. These default locations may not meet your requirements as to where you are saving your data. You can use the Active Setup portion of Preferences to change these defaults to more meet your requirements.

In Active Setup, you can also choose which background map or detailed map you want to use.

Changing the Default Folders

You can set the default for POI's, routes, and geocache files.

1. Press **MENU**.
2. Use the **Arrow** joystick to highlight **Preferences**.
3. Press **ENTER**.
4. Use the **Arrow** joystick to highlight **Active Setup**.
5. Press **ENTER**.
6. Use the **Arrow** joystick to highlight the field that you want to change.
7. Press **ENTER**.
8. Use the **Arrow** joystick to select **Select File** or (**POI, Route, Detail Map, etc.**) **File Off**.

Note: Selecting **File Off** turns the default file off. When accessing the data for items you have turned off, you will be taken to the top level folder for the particular kind of data you are accessing. Background maps cannot be turned off.

9. Press **ENTER**.
10. If you selected **Select File**, using the **Arrow** joystick to highlight the file you want to set as the default. When it is highlighted, press **ENTER**.



Selecting the Background or Detail Map

The eXplorist comes with a basemap already installed but you may use MapSend Worldwide software (purchased separately) to define your own basemap. You can use Active Setup to select the background map you want to use if you have stored a new one.

Also, you can use one of the other MapSend software packages to define and save detailed maps to your eXplorist. These detailed maps can provide more detailed street information, additional POIs, and if using one of the MapSend topographic software packages, topo details. You can use Active Setup to select the detail map you want to use if you have one saved.

1. Press **MENU**.
2. Use the **Arrow** joystick to highlight **Preferences**.
3. Press **ENTER**.
4. Use the **Arrow** joystick to highlight **Active Setup**.
5. Press **ENTER**.
6. Use the **Arrow** joystick to highlight the **Background Maps** or **Detail Maps** field.
7. Press **ENTER**.
8. Use the **Arrow** joystick to highlight the desired map.

Note: If you select Detail Map, you have the option of **Select Map** or **Detail Map Off**. If you want to not use or do not have a detail map saved, select **Detail Map Off** and press **ENTER**.

9. Press **ENTER**.

Setting the Map Units

In the Map Units option of Preferences you can select which units of measure for navigation data, the north reference, the coordinate system and the map datum that will be used by the eXplorist.

Selecting Navigational Units of Measure

The eXplorist can be set to display navigation data in Miles/Yd/MPH, Miles/Ft/MPH, NM/Ft/Knots, NM/M/ Knots or KM/KPH.

1. Press **MENU**.
2. Use the **Arrow** joystick to highlight **Preferences**.
3. Press **ENTER**.
4. Use the **Arrow** joystick to highlight **Map Units**.
5. Press **ENTER**.
6. Use the **Arrow** joystick to highlight the data field for **Nav Units**.
7. Press **ENTER**.
8. Use the **Arrow** joystick to highlight the desired navigational units of measure.
9. Press **ENTER**.

The *Map Units* screen is displayed with the new nav units shown. You can change other settings or press **ESC** to return to the Preferences menu.

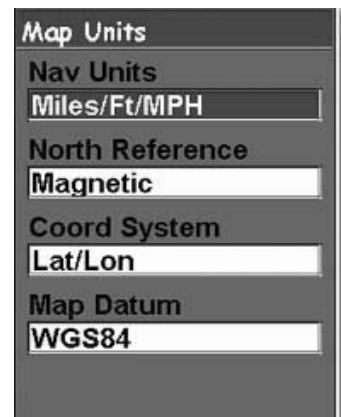

Selecting the North Reference

You can set the North Reference used by the eXplorist to be either magnetic north or True North.

1. Press **MENU**.
2. Use the **Arrow** joystick to highlight **Preferences**.
3. Press **ENTER**.
4. Use the **Arrow** joystick to highlight **Map Units**.
5. Press **ENTER**.
6. Use the **Arrow** joystick to highlight the data field for **North Reference**.
7. Press **ENTER**.
8. Use the **Arrow** joystick to highlight **Magnetic** or **TRUE**.
9. Press **ENTER**.

The *Map Units* screen is displayed with the new **North Reference** shown. You can change other settings or press **ESC** to return to the *Preferences* menu.

Selecting the Coordinate System

Position data will be displayed in the coordinate system chosen in Map Units. The default system is latitude/longitude (Lat/Lon) and should be fine for most users. Experienced navigators will want to select a coordinate system that matches the maps or charts they are using. Coordinate systems that can be selected are:

- Lat/Lon
- OSGB
- Swiss
- Finnish
- French
- MGRS
- UTM
- Irish
- Swedish
- German
- USNG
- User Grid

1. Press **MENU**.
2. Use the **Arrow** joystick to highlight **Preferences**.
3. Press **ENTER**.
4. Use the **Arrow** joystick to highlight **Map Units**.
5. Press **ENTER**.
6. Use the **Arrow** joystick to highlight the data field for **Coord System**.
7. Press **ENTER**.
8. Use the **Arrow** joystick to highlight the desired coordinate system.
If User Grid is selected additional information is required. This option will only be used by experienced users and is not described in this manual.
9. Press **ENTER**.

The **Map Units** screen is displayed with the new Coord System shown. You can change other settings or press **ESC** to return to the Preferences menu.

Selecting the Map Datum

When using the eXplorist in conjunction with a map or chart, you should make sure that the map datum in the eXplorist matches the map datum that the map or chart uses. This can usually be found in the legend block on the map or chart. The default map datum for the eXplorist is WGS84 and should be used when in doubt.

1. Press **MENU**.
2. Use the **Arrow** joystick to highlight **Preferences**.
3. Press **ENTER**.
4. Use the **Arrow** joystick to highlight **Map Units**.
5. Press **ENTER**.
6. Use the **Arrow** joystick to highlight the data field for **Map Datum**.
7. Press **ENTER**.
8. Use the **Arrow** joystick to highlight the desired map datum.
9. Press **ENTER**.

The *Map Units* screen is displayed with the new **Map Datum** shown. You can change other settings or press **ESC** to return to the *Preferences* menu.

Using the Power Management Tool

When you are out in the field or on the water, extending the life of the batteries in your eXplorist should be something that you are mindful of. Two areas that you can control to extend the battery life are turning the eXplorist off when not in use and setting how long the display backlight will be on.

Setting the Power Off Timer

The eXplorist has a power off timer that will turn the eXplorist off after a defined time period if no buttons have been pressed or if you are not moving. This will prevent the batteries from running out if you accidentally leave the eXplorist on.

1. Press **MENU**.
2. Use the **Arrow** joystick to highlight **Preferences**.
3. Press **ENTER**.
4. Use the **Arrow** joystick to highlight **Pwr Management**.
5. Press **ENTER**.
6. Use the **Arrow** joystick to highlight the data field for **Power Off Timer**.
7. Press **ENTER**.
8. Use the **Arrow** joystick to highlight the desired time interval or set to **Off**.
9. Press **ENTER**.

Note: When using a GOTO route you should note that if the eXplorist turns off the GOTO route is erased. If you have a GOTO route activated and you think that the power timer may elapse and turn the eXplorist off, you might want to set the Power Off Timer to Off. This does not apply to multi-leg routes and BackTrack routes.

Setting the Light Timer

As has been mentioned before, the display backlight makes the display easier to read in low light situations but it also is the largest drain on the batteries. The

1. Press **MENU**.
2. Use the **Arrow** joystick to highlight **Preferences**.
3. Press **ENTER**.
4. Use the **Arrow** joystick to highlight **Pwr Management**.
5. Press **ENTER**.
6. Use the **Arrow** joystick to highlight the data field for **Light Timer**.
7. Press **ENTER**.
8. Use the **Arrow** joystick to highlight the desired time interval or set to **Timer Off**.
9. Press **ENTER**.

Personalizing the eXplorist

This function provides a way to input information about yourself that could be used to return your eXplorist should you happen to lose it. Also the name you enter in the **Name** field will be displayed on the *About* screen.

Steps to Personalize your eXplorist

1. Press **MENU**.
2. Use the **Arrow** joystick to highlight **Preferences**.
3. Press **ENTER**.
4. Use the **Arrow** joystick to highlight **Personalize**.
5. Press **ENTER**.
6. Use the **Arrow** joystick to highlight the data field for **Name**.
7. Press **ENTER**.
8. Use the **Arrow** joystick and **ENTER** button to input your name.
9. Use the **Arrow** joystick to highlight **OK** when the name is entered.
10. Press **ENTER**.
11. *Optional:* Use the **Arrow** joystick to highlight the data field for **Address**. Repeat steps 7 through 10 for your address.
12. *Optional:* Use the **Arrow** joystick to highlight the data field for **City, State, Zip**. Repeat steps 7 through 10 for your city, state and zip code.
13. *Optional:* Use the **Arrow** joystick to highlight the data field for **Telephone #**. Repeat steps 7 through 10 for your telephone number.
14. Press **ESC** to exit the **Personalize** function.

The screenshot shows a vertical menu titled "Personalize" with the following sections and input fields:

- Name**: [Enter Name]
- Address**: [Enter Address]
- City, State, Zip**: [Enter Address]
- Telephone #**: [Enter Telephone #]

Selecting Languages

The eXplorist can be set to display information from any one of ten different languages. You can select from English, Français (French), Deutsch (German), Nederlands (Dutch), Suomi (Finnish), Español (Spanish), Italiano (Italian), Português (Portuguese), Svenska (Swedish) and Norsk (Norwegian).

Selecting the Language for Your eXplorist

1. Press **MENU**.
2. Use the **Arrow** joystick to highlight **Preferences**.
3. Press **ENTER**.
4. Use the **Arrow** joystick to highlight **Language**.
5. Press **ENTER**.
6. Use the **Arrow** joystick to select the language desired.
7. Press **ENTER**.



Clearing Memory

The Clear Memory function of Preferences gives you a tool that you can use to globally clear:

- active track history [Track History]
- all user-entered POI's and routes [POIs/Routes]
- all multi-leg routes [Routes]
- all track history, user-entered POIs, and routes [All]. This resets the eXplorist to its original factory settings. It will erase all user-created files and folders from the internal memory. User-created files on the SD card will not be deleted.

Using Clear Memory, you can also set all of the defaults in the eXplorist to the factory defaults.

Clearing Track History

1. Press **MENU**.
2. Use the **Arrow** joystick to highlight **Preferences**.
3. Press **ENTER**.
4. Use the **Arrow** joystick to highlight **Clear Memory**.
5. Press **ENTER**.
6. Use the **Arrow** joystick to highlight **Track History**.
7. Confirm. Use the **Arrow** joystick to highlight **Yes** to confirm or **No** to cancel.
8. Press **ENTER**.



Clearing User-Entered POIs and Routes

1. Press **MENU**.
2. Use the **Arrow** joystick to highlight **Preferences**.
3. Press **ENTER**.
4. Use the **Arrow** joystick to highlight **Clear Memory**.
5. Press **ENTER**.
6. Use the **Arrow** joystick to highlight **POIs/Routes**.
7. Confirm. Use the **Arrow** joystick to highlight **Yes** to confirm or **No** to cancel.
8. Press **ENTER**.

Clearing Routes

This will clear all of the routes you have entered that are saved in the default files used internally to the eXplorer. Routes saved in files other than the default files or on any SD card installed will not be cleared.

1. Press **MENU**.
2. Use the **Arrow** joystick to highlight **Preferences**.
3. Press **ENTER**.
4. Use the **Arrow** joystick to highlight **Clear Memory**.
5. Press **ENTER**.
6. Use the **Arrow** joystick to highlight **Routes**.
7. Confirm. Use the **Arrow** joystick to highlight **Yes** to confirm or **No** to cancel.
8. Press **ENTER**.

Clearing Active Track , User-Entered POIs and Routes

This will clear all of the POIs and routes you have entered that are saved in the default files used internally to the eXplorer, as well as the active track history. POIs and routes saved in files other than the default files will not be cleared. It will erase all user-created files and folders from the internal memory.

1. Press **MENU**.
2. Use the **Arrow** joystick to highlight **Preferences**.
3. Press **ENTER**.
4. Use the **Arrow** joystick to highlight **Clear Memory**.
5. Press **ENTER**.
6. Use the **Arrow** joystick to highlight **All**.
7. Confirm. Use the **Arrow** joystick to highlight **Yes** to confirm or **No** to cancel.
8. Press **ENTER**.
9. The eXplorer will automatically shut off.

Resetting the eXplorist to Factory Defaults

1. Press **MENU**.
2. Use the **Arrow** joystick to highlight **Preferences**.
3. Press **ENTER**.
4. Use the **Arrow** joystick to highlight **Reset Default**.
5. Press **ENTER**.
6. Use the **Arrow** joystick to highlight **All**.
7. Confirm. Use the **Arrow** joystick to highlight **Yes** to confirm or **No** to cancel.
8. Press **ENTER**.

Setting Alarms

Alarms that you can set:

- **Beeper:** The beeper is set to on by default to make an audible beep whenever a button (key) is pressed or when you are to be alerted by an alarm. You can turn off this feature through this screen.
- **Anchor -** When you set the anchor alarm on, the eXplorist will alert you when it has moved a distance you have selected. This could be used when you have anchored your boat and need to be alerted if it has drifted from it's anchor point.
- **Arrival -** The arrival alarm alerts you when you have arrived to the destination of each leg in your route or to a GOTO destination. You will need to set the distance that you want to be alerted. (Arrival alarms also use the speed you are traveling as a minor factor in computing when to provide the alarm. If you have set the Arrival alarm to 250 feet and are traveling at 30 mph, the alarm will sound slightly before the 250 foot mark.)
- **Off Course -** When a route is active, the eXplorist computes when you have moved left or right of the plotted route. You can set a distance, left or right of the plotted route, that when you exceed this distance you will be alerted by an alarm.
- **GPS Fix -** The GPS fix alarm is displayed when you have lost your GPS fix for more than 20 seconds.
- **Proximity Alarm -** The proximity alarm is very similar to the arrival alarm except that it factors in speed at a higher level than the arrival alarm. The proximity alarm has two alerts. First, when you are nearing the proximity alarm distance selected and second, a visual proximity alert when you are at the distance selected.



At the bottom of the display is a field that will display information about all alarms that have been triggered since the eXplorist was last turned on.

Note: When an alarm is displayed, press ESC to clear the alarm from the screen.

Setting Alarms

1. Press **MENU**.
2. Use the **Arrow** joystick to highlight **Preferences**.
3. Press **ENTER**.
4. Use the **Arrow** joystick to highlight **Alarms**.
5. Press **ENTER**.
6. Use the **Arrow** joystick to highlight the alarm field that you want to turn off or set.
7. Press **ENTER**.
8. Select from the list of available distances the distance that you want the alarm alert to come on or select Off to turn off the alarm.

Note that the GPS Fix alarm does not offer any distance, just **On** or **Off**.

9. Press **ENTER**.

Setting the Clock

Under normal usage, you should never need to change the clock setting unless you cross over into a new time zone. The eXplorist receives its clock information from the atomic clock located in the GPS satellite and is extremely accurate.

Other than changing the time for when you cross time zones, you can also set the format that the time is displayed as well as select the daylight savings time settings.

Setting the Time & Format

To adjust the time you must first select a format that the time will be displayed in. If the format you are presently using is the format you want to keep, you still need to verify the format before you can set the clock.

1. Press **MENU**.
2. Use the **Arrow** joystick to highlight **Preferences**.
3. Press **ENTER**.
4. Use the **Arrow** joystick to highlight **Clock**.
5. Press **ENTER**.
6. Use the **Arrow** joystick to highlight the **Format** field.
7. Press **ENTER**.
8. Select **Local 24 Hrs**, **Local AM/PM**, or **UTC**.
9. Press **ENTER**.
10. With the clock field highlighted, press **ENTER**.
11. Use the **Arrow** joystick to set the time.
(Up/down changes the value at the cursor location; left/right moves the cursor.)
12. When the time is set properly, press **ENTER**.
13. With the **Done** button highlighted, press **ENTER**.



Setting Daylight Savings Time

1. Press **MENU**.
2. Use the **Arrow** joystick to highlight **Preferences**.
3. Press **ENTER**.
4. Use the **Arrow** joystick to highlight **Clock**.
5. Press **ENTER**.
6. Use the **Arrow** joystick to highlight the **Daylight Savings** field.
7. Press **ENTER**.
8. Use the **Arrow** joystick to highlight the **Region** field.
9. Press **ENTER**.
Select **United States**, **European Union**, **Custom**, or **Disable**.
Press **ENTER**.
10. If **Custom**: You need to enter the information about the start and end dates for daylight savings. Highlight each of the fields and press **ENTER**. Select one of the options from each of the popup menus and press **ENTER**.
When all of the information has been entered and is correct, press **ESC** to return to the *Clock* screen.

Performance

Receiver	14 parallel-channel technology, tracks up to 14 satellites to compute and update information	
Antenna	Patch	
Acquisition Times (optimal conditions)		
	Warm	less than 1 minute
	Cold	less than 2 minutes
Update Rate	1 second continuous	
Accuracy		
	Position	7 meters, 95% 2D RMS w/WAAS/EGNOS <3 meters, 95% 2D RMS
	Velocity	0.1 knot RMS steady state
Limits		
	Speed	951 MPH - 1530.5 KM/H
	Altitude	60,000 ft. - 18,600 meters

Physical

Weight	12 ounces - 340 grams (with battery installed)
Size	6.5" x 2.9" x 1.3" [h] x [w] x [d] 164.5 mm x 74 mm x 33 mm
Display	2.8" x 2.0" [h] x [w] 71 mm x 53.3 mm color, high contrast LCD with backlit display
Housing	Weatherproof construction, wraparound rubber armor
Temp. Range	Operating: 14°F to 140°F (-10°C to 60°C)

Power

Source	4 AA Batteries
Battery Life	Up to 19 hours with backlight display on low

Memory

64 MB internal memory

Coordinate Systems

Available	11 plus 1 user grid. Lat/Lon, UTM, OSGB, Irish, Swiss, Swedish, Finnish, German, French, USNG and MGRS
-----------	--

Routes

Total	Unlimited (using SD cards) GOTO route BackTrack route
Name Length	10 characters (including spaces)

Track Logs

Total	Unlimited saved Track Logs plus active Track Log (using SD Cards)
-------	---

Points of Interest

User-entered	
Total	Unlimited saved Points of Interest (using SD cards)
Name Length	20 characters (including spaces)
Built-in (included with background map)	
Categories	Cities, highways, airports, waterways and parks.

Navigation Screens

Map	Includes background map and 2 data fields (customizable)
Compass	Includes graphical compass and 2 data fields (customizable)
Position	Includes position, elevation, accuracy, date and time, trip odometer and battery life

Alarms

Anchor Alarm	Alerts when moved a user-defined distance
Off Course Alarm	Alerts when more than a user-defined distance, left or right of computed track
Arrival Alarm	Alerts when within a user-defined distance of destination
Proximity Alarm	Alerts when within a user-defined distance of destination

Expand the use of your Magellan eXplorist with accessories from the Magellan Online Store for all of your adventures.

Carrying Case

Specially designed for your Magellan eXplorist, this rugged black canvas carrying case attaches conveniently to our belt or pack strap. It features handy pockets for carrying extra batteries. Protect your Magellan eXplorist while traveling or being stored.

Swivel Mount

Conveniently mount your Magellan eXplorist in your car, truck, boat or virtually any vehicle. This easy-to-install mounting bracket securely holds your receiver for optimal viewing while on-road or off-road, or on the water, wherever your adventure takes you.

Bike Mounting Bracket

Conveniently mount your Magellan eXplorist in your car, truck, boat or virtually any vehicle. This easy-to-install mounting bracket securely holds your receiver for optimal viewing while on-road or off-road, or on the water, wherever your adventure takes you.

Vehicle Mount

Strong suction cups conveniently secure your Magellan eXplorist to the windshield of your car, truck or RV. Full tilt and swivel positioning enables optimal viewing of your receiver whenever your adventure takes you.

To order accessories you can go to the Magellan Online Store at:

www.magellangps.com/en/store/

for a complete listing of these and any additional accessories that are available for your Magellan eXplorist.

Contacting Magellan Support

The following information is provided so that if you need support for your Magellan eXplorist, you can direct your questions/comments to the proper person at Thales Navigation.

Contacting Magellan in North America

Technical Support

If you need technical assistance, "how-to" help, or if you have a technical question about the functionality of your Magellan product, please contact us on the internet at www.magellangps.com or you may reach technical support by fax or by phone.

Our technical support phone representatives are available Monday through Friday, 6:00 a.m. to 5:00 p.m. P.S.T/P.D.T.

Telephone: 800-707-9971 or +1 909-394-5000 (Outside North America).

You may also reach technical support by fax: +1 909-394-7050 [Attn: Tech. Support].

E-mail: magellansupport@thalesnavigation.com

Warranty Service

To obtain warranty service on your unit, the consumer must contact us for a return authorization prior to shipment of product. Packages arriving at our dock without an RMA may be refused. To obtain an RMA, simply contact our technical support group at:

Tel: 800-707-9971 or 909-394-5000

Fax: 909-394-7050 [Attn: Tech. Support]

E-mail: magellansupport@thalesnavigation.com

Contacting Magellan in Europe

Technical support and warranty service

For Magellan product support and warranty service information in English, French, German, Spanish, Portuguese, Dutch, Norwegian, Finnish and Danish please dial FREE PHONE:

00800MAGELLAN* (00800 62435526)

from 9 AM to 6 PM GMT & GMT+1 or send an e-mail in English, French, German, Spanish, Portuguese, Dutch, Norwegian, Finnish and Danish to: magellansupportfr@thalesnavigation.com

*free of charge phone access available from Eire, UK, Portugal, Spain, France, Belgium, The Netherlands, Germany, Austria, Switzerland, Norway, Sweden, Denmark and Finland

For Magellan product phone support in English, French or German from other Europe, Middle East or African locations please dial:

+33 2 28 09 38 00*

or send an e-mail to: magellansupportfr@thalesnavigation.com

* international communication charge according to operator.

For Magellan product phone support in other European, Middle East or African Languages please contact our distributors listed on www.magellangps.com in our dealer locator or send an e-mail to: magellansupportfr@thalesnavigation.com